



INTERNATIONAL CANOE FEDERATION

**CANOE POLO
COMPETITION RULES**

2013

Taking effect from 1 January, 2013

INTRODUCTION

The purpose of this document is to provide the rules that govern the way of running Canoe Polo ICF competitions.

LANGUAGE

The English written language is the only acceptable language for all official communications relating to these Competition Rules and the conduct of all Canoe Polo ICF competitions.

For the sake of consistency, British spelling, punctuation and grammatical conventions have been used throughout.

Any word which may imply the masculine gender, also includes the feminine.

COPYRIGHT

These rules may be photocopied. Great care has been taken in typing and checking the rules and the original text is available on the ICF website www.canoeicf.com. Please do not re-set in type without consultation.

TABLE OF CONTENTS

Article	Page
CHAPTER I - GENERAL REGULATIONS	
1. AIM	7
2. INTERNATIONAL COMPETITIONS.....	7
3. COMPETITORS.....	8
4. INTERNATIONAL COMPETITION CALENDAR.....	9
CHAPTER II - ORGANISATION OF THE COMPETITION	
5. FORM OF COMMUNICATIONS	10
6. INVITATIONS	10
7. ENTRIES.....	11
8. DETERMINATION OF CATEGORIES	12
9. SELECTION OF ENTRIES.....	12
10. ADVICE OF ACCEPTANCE	12
11. SYSTEM, PROGRAMME AND SCHEDULE LIMITATIONS	13
12. COMPETITION SYSTEM	13
13. LEAGUE POINTS AND POSITIONS	14
14. ADVANCEMENT TO LATER ROUNDS	15
15. TIE BREAKING	15
16. SCHEDULE AND PROGRAMME	16
17. COMPETITION AREAS.....	16
18. SCRUTINEERING.....	17
19. HONOURABLE PLAY	18
20. OUTSIDE ASSISTANCE OR INTERFERENCE	18
21. ANTI-DOPING.....	18
22. COMPLETION OF PLAY	19
23. RESULTS	19
24. REPORTS.....	19
25. PARTICIPATING DELEGATIONS.....	19
26. OFFICIALS.....	20
27. ORGANISING COMMITTEE.....	21
28. COMPETITION COMMITTEE	21
29. APPOINTMENT OF OFFICIALS.....	21
30. DUTIES OF THE ORGANISING COMMITTEE.....	21
31. DUTIES OF THE COMPETITION COMMITTEE	23
32. DUTIES OF OFFICIALS	24
33. INTERNATIONAL CANOE POLO OFFICIALS	29
34. INTERNATIONAL CANOE POLO REFEREES.....	30
CHAPTER III - GAME REGULATIONS	
35. PLAYING AREA	32
36. PLAYING AREA BOUNDARIES AND MARKERS.....	32
37. GOALS.....	33
38. THE BALL	33
39. GAME OFFICIALS	34
40. REFEREES.....	34
41. GOAL LINE JUDGES.....	35
42. SCRUTINEER	36
43. TIMEKEEPERS.....	36
44. SCOREKEEPER.....	37
45. NUMBER OF PLAYERS	37
46. CHOICE OF END	37

47.	IDENTIFICATION	37
48.	KAYAKS	38
49.	PADDLES	38
50.	PERSONAL EQUIPMENT	39
51.	TRADE-MARKS AND ADVERTISING SYMBOLS.....	39
52.	EXCHANGING EQUIPMENT	39
53.	SCRUTINEERING.....	40
54.	PLAYING TIME.....	40
55.	TIME-OUT	40
56.	COMMENCEMENT OF PLAY.....	41
57.	BALL OUT OF PLAY	42
58.	SCORING A GOAL	43
59.	RESTART AFTER GOAL	43
60.	CAPSIZED PLAYER	43
61.	ENTRY TO THE PLAYING AREA, RE-ENTRY, SUBSTITUTION AND EXCHANGING EQUIPMENT	44
62.	ILLEGAL SUBSTITUTION AND ENTRY TO THE PLAYING AREA	44
63.	ILLEGAL USE OF THE PADDLE.....	45
64.	ILLEGAL POSSESSION	45
65.	ILLEGAL HAND TACKLE	46
66.	ILLEGAL KAYAK TACKLE	46
67.	ILLEGAL JOSTLE	47
68.	ILLEGAL OBSTRUCTION	47
69.	ILLEGAL HOLDING	48
70.	UNSPORTING BEHAVIOUR	48
71.	DEFENCE OF GOAL	49
72.	REFEREE'S BALL	50
73.	ADVANTAGE	51
74.	SANCTIONS	52
75.	TAKING THROWS	55
76.	TAKING A GOAL PENALTY-SHOT.....	57
77.	COMPLETION OF PLAY	57
78.	OVERTIME.....	57
79.	PROTEST TO THE COMPETITION COMMITTEE.....	57
80.	DISCIPLINARY ACTION BY THE COMPETITION COMMITTEE.....	60

CHAPTER IV - SPECIAL RULES FOR WORLD CHAMPIONSHIPS

81.	ARRANGEMENTS	62
82.	JURY AND OFFICIALS.....	63
83.	APPOINTMENT	63
84.	ENTRIES.....	64
85.	SYSTEM, PROGRAMME AND SCHEDULE LIMITATION	65
86.	SELECTION OF COMPETITION SYSTEM	65
87.	TRADEMARKS, ADVERTISING SYMBOLS AND WORDS	65
88.	THE BALL	66
89.	IDENTIFICATION	66
90.	PLAYING TIME.....	66
91.	PROTEST	66
92.	APPEAL.....	67
93.	AWARDS.....	67

94.	ANTI-DOPING	68
95.	RESULTS AND REPORTS	68

CHAPTER V - SPECIAL RULES FOR WORLD GAMES

96.	ENTRIES TO WORLD GAMES	69
97.	TRADEMARKS, ADVERTISING SYMBOLS AND WORDS	69
98.	SYSTEM; PROGRAMME AND SCHEDULE LIMITATIONS	69
99.	REFEREES	70

APPENDIX I - REFEREE HAND SIGNALS

REFEREE HAND SIGNALS	71
----------------------------	----

APPENDIX II - SCRUTINEERING

KAYAK - GENERAL	75
KAYAK GAUGES	78
PADDING	80
PADDLE	82
PADDLE GAUGE	82
HELMET	83
FACE-PROTECTOR	83
BODY PROTECTION	83

APPENDIX III: PLAYING AREA

PLAYING AREA	84
--------------------	----

APPENDIX IV: GAMES AND LEAGUE SYSTEMS

GAMES AND LEAGUE SYSTEMS	85
--------------------------------	----

APPENDIX V: SHOT CLOCK

SHOT CLOCK	86
------------------	----

List of Abbreviations

ICF	International Canoe Federation
CAPC	Canoe Polo Committee
GR	General Rules (can only be changed by ICF Congress)
TR	Technical Rules (can be changed by ICF Board of Directors)
Competition	World Championships, International Competitions
Categories	Men, Women, Master Men, Master Women, Under-21 Men, Under-21 Women
Classes	Kayak

CHAPTER I - GENERAL REGULATIONS

1. AIM

[GR]

1.1. The aim of Canoe Polo is a competitive ball game between two teams, each of five players. Players paddle polo kayaks, on a well-defined area of water, attempting to score goals against the opposition. The winning team in a game is the team that scores the most goals.

2. INTERNATIONAL COMPETITIONS

[GR]

2.1 All competitions announced as international shall be held in accordance with the regulations of the ICF. Competitions arranged by National Federations or their clubs are considered international if teams of a foreign country are invited to participate.

2.2 International competitions must be controlled by at least one accredited official in possession of a valid discipline related International Official card.

2.3 The official categories recognised by the ICF are the following: Men, Women, Under-21 Men, Under-21 Women, Masters Men, Masters Women.

2.4 Mixed competitions in which male and female competitors take part, either in the same competition or in a category with each other, are not permitted.

2.5 A player may only play in one category in any one competition. Once a player has been listed on the final application (allowing for changes to be accepted up to one hour prior to the commencement of the competition), that player may not play for any other team in that competition, in any category.

2.6 For competitions, where the Organising Committee is unable to fully comply with the ICF Canoe Polo regulations, a variation to the rules in chapter 2 may be allowed.

3. COMPETITORS

[GR]

3.1 Only the members of clubs or associations affiliated with an ICF National Federation have the right to participate in an international competition.

3.2 A competitor is always allowed to take part individually in an international competition but must in each case obtain special permission from his/her National Federation.

3.3 A competitor may take part on behalf of the federation in a foreign country in which he/she is domiciled, if he/she obtains the authorisation of his/her federation of origin. This authorisation has to be sent before the 30th November prior to the year concerned to the ICF Headquarters with a copy to the Chairperson of the Committee concerned. The same procedure applies, should the Competitor change back his/her starting right to the Federation of origin.

3.4 If he/she lived for 2 years or more in this foreign country, the approval of his/her federation of origin is no longer required.

3.5 A competitor may not compete for more than one federation in any calendar year in the sport of canoeing. This rule does not apply in the case of a competitor who leaves his/her country of origin to marry in another country. He/she can, in this case, compete for his/her new federation without awaiting the delay of two (2) years.

3.6 The first year an Under-21 competitor can compete is in the year that his/her fifteenth (15th) birthday falls in and the last year he/she can compete is in the year that his/her twenty-first (21st) birthday falls in.

3.7 The first year a master competitor can compete is the year of his/her thirtieth (30th) birthday. The age group will be 30+ and 45+ for Men and Women.

3.8 Documentary proof, such as passport, will be required at the time of competition to confirm eligibility status.

4. INTERNATIONAL COMPETITION CALENDAR

[GR]

Before the 1st August of each year all national federations shall send, one copy to the ICF Headquarters, and one to the Chair of the Committee concerned, their proposed Programme of international competitions for the coming year.

Federations may complete or modify the calendar till 30th September. Beyond this date the calendar shall be considered finalised and published.

CHAPTER II - ORGANISATION OF THE COMPETITION

5. FORM OF COMMUNICATIONS

[TR]

All communications should be in writing (Letter, Fax, E-mail, Telegram, Telex, etc.). Where verbal communication is used, it must also be confirmed in writing by the given deadline (midnight on the due date). In the eventuality of conflicting information, the information with letterhead and/or signature will take precedence.

6. INVITATIONS

[GR]

An invitation to an international competition shall be sent out a minimum of 12 weeks prior to the competition and shall contain the following information:

6.1.1. Type of competition;

- Categories of the Competition;
- Proposed programme or system of the competition draw or minimum number of games per team;
- The Clubs or Federations invited to send teams;
- The number of teams invited from each Club or Federation for each category;
- The process of elimination or selection that will be used to reduce the number of teams at Competition, to the required number if the competition is over subscribed;
- Time and place of the competition;
- Details of Venue(s) - for example Indoor or Outdoor;
- Amount of entry fee (if any);

6.1.2. The invitation shall contain a preliminary entry form with:

The address to which entries and competitors delegation details must be sent; the final dates and times for entries, for declaration of delegation details, for declaration of final team lists, for declaration of player lists.

6.1.2.1. Information regarding accommodation should be sent with the invitation if possible.

6.1.2.2. Information regarding publicity, progress, and details of entries received or indicated etc. must be provided on request.

7. ENTRIES

[GR]

7.1 The National Federation must endorse preliminary application for Entry of national teams. Clubs must endorse Preliminary applications for Entry of club teams; state for state teams etc.

7.2 The Organising Committee must receive preliminary applications for entries at least 8 weeks prior to the competition. Late Applications for Entry cannot be accepted.

7.3 A Preliminary application for Entry shall, contain as a minimum the following details for the competitors delegation and all the teams entered in the delegation:

- The name of the Club or Federation which the competitors' delegation is representing;
- The full name and contact details of the delegation leader;
- The name of each team;
- The category in which each team wish to compete;
- Where the entry of one team is conditional upon the acceptance for entry of another team, this must be clearly specified in the Application for Entry.

7.4 The National Federation must endorse final applications for Entry of national teams. Final applications for Entry of club teams must be endorsed by clubs, state-by-state etc.

7.5 The Organising Committee must receive final applications for entries at least 4 weeks prior to the competition. Late Applications for Entry cannot be accepted.

7.6 A Final application for Entry shall, at least contain the following details for the delegation and all the teams entered in the delegation:

- The full name and contact details of the delegation leader;
- Details of Team Leaders and Other Team Officials, last name, first name and function;

- Details of Players, last name, first name, date of birth, gender, player-number;
- Details of team identification, colours;

7.7 The Organising Committee must acknowledge final applications for Entry within 48 hours of receipt. Any problems with the Final application for Entry must be notified at this time.

7.8 The withdrawal of an entry or Application for Entry at any time after the close of Applications for Entry is final.

7.9 The Organising Committee can charge an entry fee. Entry fees are not refundable once the Application for Entry has been accepted. If teams cannot be fitted into the competition, their Application for Entry shall be refused and the entry fees shall be refunded.

7.10 No changes may be made to team details after completion of the accreditation process, or the team leaders meeting if there is no formal accreditation process.

8. DETERMINATION OF CATEGORIES [TR]

8.1 If a category has too few teams applying for entry, teams Applications for Entry may be transferred into another category. This can only be done as per the instructions on the team Application for Entry and subject to the eligibility of the players for the new category.

8.2 If teams cannot be fitted into the competition in this way, their Application for Entry shall be rejected.

9. SELECTION OF ENTRIES [TR]

If more teams enter a competition than can be accommodated, due to the categories being conducted and the maximum number of games, the Organising Committee shall use an equitable system to determine the number of teams to be accepted in each category.

10. ADVICE OF ACCEPTANCE [TR]

10.1 Final acceptance or rejection of an entry must be advised within 48 hours of such a decision being made, and in no case later than 10 days after the close of entries, by the Organising Committee.

10.2 All senders of an Application for Entry will be advised of the teams whose entries have been accepted and any that may have been required to be refused, with an explanation of the selection process.

11. SYSTEM, PROGRAMME AND SCHEDULE LIMITATIONS

[TR]

11.1 More than one venue may be used for the early part of the competition.

11.2 The games of the final round must be held at the same venue.

11.3 A team shall not be required to play at more than one venue on any single day.

11.4 A team shall not be required to play games spread over more than 9 hours on a single day.

11.5 A team shall not be required to play its first game of the day less than 12 hours after its last game of the preceding day.

11.6 A team shall not be required to play more than six (6) games on a day.

11.7 A team shall not be required to play more than three (3) games in any period of 4 hours.

11.8 A team shall not be required to play a game less than half an hour after completion of its previous game.

11.9 A team should play at least one game on the same day as and prior to playing in a Grand Final.

12. COMPETITION SYSTEM

[TR]

12.1 Competitions will be held using a suitable system for the number of participating teams. Competition Systems are selected from the list in the Appendix IV: Game and League Systems, for each category of the competition will be such that each team in each category should, where possible and on average, play

nearly the same number of games as teams in the other categories. The competition system selected for a particular category determines the number of teams from each group that advance to any Intermediate Round and how many advance direct to the Final Round.

12.2 For the preliminary round, the teams entered in each category shall be divided into equal, or near equal size groups.

12.3 Which teams shall be allocated to which Preliminary Round Groups shall be determined in a manner:

12.4 Based on a ranking list provided by the ICF Canoe Polo Committee or regional organisation (where available), or proven relative strengths of teams;

12.5 Ensuring the stronger and weaker teams are evenly spread through the groups;

12.6 In a competition with more than one round, all teams in a group shall play each other at least once in a league system. At the completion of this round, the teams are ranked in each group according to their results. The top two (2) or more teams from each group shall progress to subsequent Rounds of Competition.

12.7 An Intermediate Round, is not required in all competitions. It will only be used when there are a large number of teams in a category relative to the number of games that can be allocated to the category. In the Intermediate Round teams that have qualified from the Preliminary Round may be divided into groups, each group playing a league or knockout system to determine progression to the final round.

12.8 In the final round teams play each other in a knockout system, as per the final series systems in the Appendix. Teams are progressively eliminated until the last two teams play each other in a Grand Final to decide the winner.

13. LEAGUE POINTS AND POSITIONS

[TR]

13.1 In league competitions the following procedure shall be followed to decide placing in the group upon completion of all games for the group:

13.2 If any team is disqualified from a game or the competition the competition committee shall decide the appropriate action.

13.3 The teams in a group shall be ranked in order according to the number of points each has gained in playing the league games, the team with the most points being ranked first.

13.4 Three (3) points are awarded for a win, one (1) point for a draw, and zero (0) points for a loss. Where a team is unable to play a game or forfeits a game they will be awarded no points and the score will be recorded as a 7-0 loss for the forfeiting team.

13.5 Where two or more teams have gained the same number of points, they shall be ranked in order according to the following procedures:

- (a) Goal difference;
- (b) Total number of Goals scored;
- (c) Results of game between the two teams within that group;
- (d) Play Off, if possible.

13.6 Goal difference: Overall Goals Scored minus Overall Goals Conceded.

13.7 If one team has had a game conceded to them by another team, and a further team on the same points have actually played this conceding team, then both of these results will be discounted for this differentiation.

14. ADVANCEMENT TO LATER ROUNDS

[TR]

The competition system selected for a category determines the number of teams from each group that advance to the Intermediate Round and how many advance direct to the Elimination Finals, according to the number of teams in the category and the number of games allocated for the category.

15. TIE BREAKING

[TR]

Where a game is tied at the end of normal playing time and a result is required then Overtime (Chapter 3, article 78) will be played to obtain a result.

16. SCHEDULE AND PROGRAMME

[TR]

16.1 The program for an international competition shall be sent out at least two (2) weeks prior to the competition:

16.2 The programme and schedule of games determined once published, shall only be modified with the approval of the Organising Committee. Alterations must be notified in writing to all delegation leaders and to each team leader.

17. COMPETITION AREAS

[TR]

17.1 The following areas are pertinent to the rules for the conduct of games:

17.2 The Playing Area as defined in the Rules of Play. This is reserved during a game solely for the players in the game in progress, and immediately prior to the game for those players to use for continued warm-up.

17.2.1 A scoreboard shall be maintained to clearly display the score to the players. Where the scoreboard has a clock the scoreboard should be located on the halfway line or where there are two scoreboards they should be positioned in the same relative position at either end of the pitch, or both on the halfway line.

17.3 The Substitutes Area is the area behind the Goal Line excluding the area four (4) metres either side of the centre of the goal frame. These are reserved during a game for substitutes waiting to take part in a game.

17.4 The Referee's Area. This is the area required by each Referee controlling a game to run up and down the side of the Playing Area. No other person but game officials is permitted to enter this area during a game.

17.4.1 The Referee's area should ideally be 2m and no more than 5m from the Playing Area. The Referee's Area shall be separated from the spectator area by a distance of at least one metre and a physical barrier sufficient to prevent any spectator touching or directly approaching the Referee.

17.5 The Warm-Up Area is an area, which may be available outside the Playing area and Substitutes Area for teams to warm-up prior to their game. This must be separated from the Playing Area to prevent accidental

entry of practice balls into the Playing Area. This Warm-Up Area will be reserved solely for the use of players preparing for the next game.

17.6 The Officials Area. This is a designated area around the pool, including behind the goals and behind the Referee's Area. Only people directly involved in the game in progress or the game about to commence (Officials, Players, listed team personnel such as Coach, Manager, Doctor) or accredited media representatives, are permitted in the Officials Area during a competition.

17.7 The Competition Area. This is a wider area around the pool, including the playing, coaching, warm-up and Referee's areas, and may include designated rooms such as changing rooms, equipment storage area etc. Spectators and the general public should be restricted from this area. Any official may request the removal from this area of people interfering with the smooth running of the competition.

17.8 The Coaches Area. This is a designated area starting one metre behind the goal line and extending across the field behind the goal line (if a solid area exists) to the edge of the substitutes area on either side of the goal. The area should be clearly marked. Coaches and other Team Officials may pass through the area behind the goal but must not remain in this area.

18. SCRUTINEERING

[TR]

18.1 The times, places and procedures for Scrutineering of playing equipment for entry to the Competition Area will be advised to all teams at least twenty-four (24) hours before the equipment needs to be scrutineered. Provision will be made for checking equipment into the Competition Area on each day prior to the start of the first game.

18.2 Scrutineers shall inspect all playing equipment, prior to any admission to the Competition Area, for compliance with the rules. If equipment does not comply, it will not be permitted entry to the Competition Area. If it does comply, it will be marked in a distinctive way clearly visible on inspection.

18.3 Personal protection equipment will be required to be inspected on the intended wearer to ensure suitability for the size of the intended wearer.

18.4 Players' equipment is subject to scrutineering before, during or after a game.

A referee must dismiss from the playing area, once aware of the infringement, any player whose equipment is in breach of the rules, either at the first break in play or immediately if the equipment is potentially dangerous.

19. HONOURABLE PLAY

[TR]

19.1 Any team, which plays a game other than by honourable means, will have such conduct considered by the Competition Committee. The Competition Committee may take whatever action it sees fit and that team may be disqualified from the competition.

19.2 Team Leaders may discuss any concerns about the appointment of referees or other officials on behalf of their teams with the Chief Referee. Any other team member or team official who try to influence the appointment of any referee or other official to any game will immediately be referred to the competition committee for disciplinary action which may result in that team being disqualified from the competition.

20. OUTSIDE ASSISTANCE OR INTERFERENCE

[TR]

20.1 No electrical assistance may be used to direct or communicate with the players during a game, other than communications by Competition Officials.

21. ANTI-DOPING

[TR]

21.1 Doping as defined in the Olympic Movement Anti-Doping Code is strictly forbidden. Anti-Doping control shall be conducted in accordance with the ICF Anti-Doping control regulations under the supervision of the ICF Medical & Anti-Doping Committee.

22. COMPLETION OF PLAY

[TR]

22.1 All members and officials of a team must leave the playing, substitute and Officials Area's immediately upon completion of their game. They must also ensure that all their equipment is removed from these areas.

23. RESULTS

[TR]

23.1 The Organising Committee shall send the results of each competition within ten (10) days to the ICF Canoe-Polo Committee, to each National Federation with teams participating, and to each delegation leader where non-national teams are concerned.

24. REPORTS

[TR]

24.1 The Organising Committee must send reports of any Protests or Appeals within ten (10) days to the ICF Canoe-Polo Committee, to each National Federation with players or officials involved, and to each delegation leader of non-national teams with players or team officials involved.

25. PARTICIPATING DELEGATIONS

[TR]

25.1 The members of a delegation participating in an International Competition will be one (1) delegation leader, one (1) team leader per team, a maximum of ten (10) players per team and a maximum of three (3) other team officials per team.

25.1.1. Delegation leader

A federation or club will for every competition appoint a delegation leader who will be responsible for the delegation during the competition.

25.1.2. Team-leader

A federation or club will for every competition appoints a team-leader for each team who will be responsible for the team during the competition.

25.1.3. Players

Players are defined in Chapter 1, General Regulations, Article 3.

A maximum of 10 players may be named for a team.

25.1.4. Additional team officials

A federation or club can for every competition appoint a maximum of three (3) additional team officials for each team who will be part of the official delegation (For example a coach, equipment-manager or doctor).

25.2 Identification

The members of a delegation requiring access to the competition area will be clearly identified as to their role and team.

26. OFFICIALS

[TR]

26.1 International competitions shall be held under the supervision of the following officials:

- Chief Official
- Competition Organiser
- Technical Organiser
- Chief Referee
- Chief Scrutineer
- Chief Table Official
- Timekeepers
- Scorekeepers
- Referees
- Goal Line Judges
- Scrutineers

26.2 If circumstances permit, one person may function in two or more of the above offices. All Competition Officials shall be clearly identified, both in name and in position, whilst performing their duties.

26.3 An International competition must be controlled by at least one accredited official in possession of a valid International Canoe Polo Official card. This official should preferably be the Chief Official or another member of the Competition Committee.

26.4 **Where possible**, all games must be refereed by neutral Referees, i.e. from countries other than those represented by the two teams playing, excepting if the two teams are from the same country. If this is not possible then one referee should be from each country involved in the game.

27. ORGANISING COMMITTEE

[TR]

27.1 The hosting federation or club will, for each competition, appoint an Organising Committee that will organise the competition.

28. COMPETITION COMMITTEE

[GR]

28.1 The overall control of any Competition shall be in the hands of a Competition Committee that shall consist of:

28.1.1. The Chief Official, as Chairperson;

28.1.2. The Competition Organiser, and

28.1.3. One additional person who is appointed as an official.

29. APPOINTMENT OF OFFICIALS

[TR]

29.1 The following groups are responsible for appointing the following officials:

Chief Official Competition Organiser Technical Organiser Chief Referee Chief Scrutineer Chief Table Official	Organising Committee
Timekeepers Scorekeepers	Chief Table Official
Referees Goal Line Judge	Chief Referee
Scrutineers	Chief Scrutineer

30. DUTIES OF THE ORGANISING COMMITTEE

[TR]

30.1 The hosting federation or club shall establish the Organising Committee. The structure of the Organising Committee will be the responsibility of the host federation or club.

30.2 The Organising Committee shall be responsible for:

- Proposing the competition;
- Making all necessary arrangements to ensure adequate participation of all eligible teams;
- Providing a schedule of competitions;
- Providing venue and equipment;
- Making arrangements for accommodation and transport of visiting teams within the host country;
- Providing officials as requested by Competition Committee;
- Providing scrutineering equipment;
- Providing additional assistance as reasonably required by the Competition Committee in matters such as publicity, presentations etc.
- Administering the non-official aspects of the competition, such as spectators and media;
- Appointing a Competition Organiser to liaise with the Competition Committee.

30.1 The Organising Committee shall

30.1.1. Ensure the provision of all necessary information to the representatives of the media about the teams, players, officials and progress of the competition. In this regard, information can be requested from all officials who will provide it as soon as is possible.

30.1.2. Ensure that volunteers are provided to ensure the supply of correct sized balls for Referees and Goal Line Judges throughout the games. These volunteers shall wear a uniform. The uniforms will be distinctive coloured shirts indicating their role, which shall be different to the Referee's and Goal Line Judges uniform.

30.1.3. Ensure the provision of all playing equipment, including goals, boundary markers, balls etc. and equipment for associated areas, and ensuring the equipment remains operational throughout the competition;

30.1.4. Ensure the provision of all announcing scoring, results keeping and timing equipment and assisting the Chief Table Official in ensuring the timing and scoring equipment remains operational throughout the competition;

30.1.5. Liaise with venue management in case of any problem with venue provided equipment or facilities;

30.1.6. Provide an area for storage and maintenance of the teams equipment during the course of the competition;

30.1.7. Arrange for the announcement of the schedule of games in a manner that ensures the necessary teams and officials are ready in time for each game;

30.1.8. Announce which teams are competing and the significance of each game prior to the game commencing;

30.1.9. Announce the result of a game, at the completion of the game, and the significance of the result and the subsequent progress of each team according to the result.

30.1.10. Arrange for the recording of the results of each game and compile the results of games into a league table or knockout diagram as required;

30.1.11. Arrange for the updating of the programme with actual team names where these are dependent on the results of the game;

30.1.12. Display the results of each game, the updated league tables or knockout diagram, and the updated programme, for the team's and spectators immediate inspection and passing such information to the Media as required.

30.4 All matters relating to Invitations and Entries, undertaken by the Organising Committee, are supervised by the Competition Organisers and are subject to the approval of the Competition Committee.

31. DUTIES OF THE COMPETITION COMMITTEE

[TR]

31.1 The Competition Committee must:

31.1.1. Supervise the organisation and arrangement of the competition;

Consider and approve a panel of:

- Timekeepers and Scorekeepers from nominations submitted by the Chief Table Official.

- Referees and Goal Line Judges, from nominations submitted by the Chief Referee.
- Scrutineers, from nominations submitted by the Chief Scrutineer.

In case of unforeseen circumstances that make it impossible to carry out the competition to schedule, either approve variation to the schedule or postpone the competition and decide, in conjunction with the Organising Committee, on another time when it may be held.

31.1.2. Hear any protests that may be made and settle any disputes that may arise.

31.1.3. Decide action in cases where any regulations are broken. Decisions shall be based on the ICF Canoe Polo Rules. Penalties in accordance with the ICF Statutes may also be imposed. For example disqualification for a longer period than the duration of the competition in question.

32. DUTIES OF OFFICIALS

[TR]

32.1 Chief Official

As Chairperson of the Competition Committee the Chief Official shall:

32.1.1. Have overall responsibility for all official aspects of the competitions, supervising the other Officials in this regard;

32.1.2. Ensure all matters are dealt with according to these rules. Decide all matters that are not dealt within these rules that are not exclusively the concern of the Organising Committee.

32.2 Competition Organiser

The Competition Organiser is responsible for co-ordinating the Organising Committee in both fulfilling its obligations to the Competition Committee and achieving its own objectives in hosting the competition.

32.3 Technical Organiser

The Technical Organiser shall:

32.3.1 Co-ordinate the administration of the competition during the period of the competition, to

ensure the smooth running of the programme of games according to schedule and rules;

32.3.2 Make any necessary variations to schedule, and publicise any such changes of schedule;

32.3.3 Have overall control over access to the competition areas.

32.3.4 Ensure that all players and teams are eligible for the competition, and that entry requirements are satisfied;

32.3.5 Keep all entry details available for inspection by the Competition Committee and Team-leaders;

32.3.6 Record all significant happenings during the competition, excepting those dealt with by the Timekeepers and Scorekeepers;

32.3.7 Keep the minutes of the proceedings of any protests or appeal hearings;

32.3.8 Oversee the performance of any commentator appointed by the Organising Committee. The Commentator is not an official;

32.4 Chief Referee

The Chief Referee shall:

32.4.1 Appoint the Referees and Goal Line Judges, after the approval of the Competition Committee ensuring that where possible, neutral Referees are used, with no affiliation to the teams competing in the game.

32.4.2 Allocate a first referee to each game.

32.4.3 Allocate duties to Referees and Goal Line Judges and ensure the standard of performance of those duties;

32.4.4 Ensure all game officials are briefed as necessary;

32.4.5 Pass on to the Chief Official all written reports from Referees on incidents where disciplinary action is requested and request that the Competition Committee consider disciplinary action against players for repeated offences.

32.4.6 Have the authority to replace a referee at any stage during a game who is unable to continue to referee due to injury, illness or other reason with a suitably qualified replacement.

32.5 Chief Scrutineer

The Chief Scrutineer shall:

32.5.1 Appoint the Scrutineers, after the approval of the Competition Committee. Where possible, neutral Scrutineers should be used, with no affiliation to the teams competing in the game.

32.5.2 Allocate Scrutineers to duties and insure the standard of performance of those duties;

32.5.3 Liaise with the Organising Committee to ensure the provision of all scrutineering equipment;

32.5.4 Ensure suitable procedures for the scrutineering of all equipment prior to admission to the competition area;

32.6 Chief Table Official

The Chief Table Official shall:

32.6.1 Appoint the Timekeepers and Scorekeepers after the approval of the Competition Committee;

32.6.2 Allocate Timekeepers and Scorekeepers to duties and ensure the standard of performance of those duties;

32.6.3 Liaise with the Organising Committee to ensure the provision of scoring, results keeping and timing equipment;

32.6.4 Ensure that the Organising Committee provides results to the official notice board, team-leaders, officials and Jury.

32.7 Timekeepers

The Timekeepers shall:

32.7.1 Advise the Referee and players when the time and schedule requires that a game should be started;

32.7.2 Time the game as per the Game Regulations.

32.7.3 Not officiate for more than two games in succession.

32.8 Scorekeepers

The Scorekeepers shall:

32.8.1 Record the game details on the official game report, name and number from the players of teams, goals scored and full details of the play. They must also note the name, number and team of player(s) sent off;

32.8.2 Pass the completed game record sheet to the Chief Table Official at the end of each game;

32.8.3 Not officiate for more than two games in succession.

32.9 Referees

32.9.1 Referees will be appointed from nominations received from all Federations and Associations eligible to participate in the competition.

32.9.2 Two (2) Referees are appointed for each game to control and officiate the game in an unbiased and impartial manner, in accordance with the Game Regulations;

32.9.2.1 The referees shall:

32.9.2.2 Provide their own equipment; the dress of referees is an appropriate black shirt and shorts or trousers. Referees should also wear sports shoes or appropriate alternatives.

32.9.2.3 Through sponsorship, and subject to approval by the competition committee, referees may wear a colour other than black provided all referees in that competition are provided with the new uniform.

32.9.2.4 Provide written reports (one from each Referee) to the Chief Referee of all incidents resulting in a player being sent off, immediately upon completion of the game in which the incident occurred. Such report should include any request for further disciplinary action;

32.9.2.5 At the request of the Competition Committee, attend and give evidence at disciplinary, protest, or appeal hearings concerning games refereed;

32.9.2.6 Follow directions from the Chief Referee;

32.9.2.7 Follow directions from the Technical Organiser, in regard to suspending play, or advancing or delaying the start of a game;

32.9.2.8 Follow directions, from the Scrutineer appointed for a game, to inspect a player's equipment at the next break of play;

32.9.2.9 Follow directions from the Chief Scrutineer to dismiss a player for breach of Conditions of Play.

32.9.3 Not referee for more than two (2) games in succession.

32.9.4 Referees, whilst acting in any capacity with their team, lose their Referee status. They should respect without question all decisions given by the Referees controlling the game. They should set an example of good sports behaviour for other players to follow.

32.10 Goal Line Judge

32.10.1 Two (2) Goal Line Judges for each game are appointed to assist the Referees, one for each Goal Line. They shall:

32.10.2 Wear a uniform whilst officiating for games. The uniforms will be distinctive coloured shirts indicating their role, which shall be different to the Referee's uniform.

32.10.3 Assist the Referees as to the Game Regulations;

32.10.4 Follow directions from the Referees;

Not officiate for more than two (2) games in succession.

32.11 Scrutineer

32.11.1 One (1) Scrutineer per game is appointed to control the equipment from the players and the equipment on the playing area as per the Game Regulations.

32.11.2 They shall wear a uniform whilst officiating for games. The uniforms will be distinctive coloured shirts indicating their role, which shall be different to the Referee's uniform.

32.12 Assistants

32.12.1 The Chief Official, Competition Organiser, Technical Organiser, Chief Referee, Chief Scrutineer and Chief Table Official may appoint people to assist them in the conduct of their duties, but they may not hand over their responsibilities to these Assistants.

33. INTERNATIONAL CANOE POLO OFFICIALS

[GR]

33.1. The ICF Canoe Polo Committee gives recognition as an International Canoe Polo Official to those persons who have passed an appropriate examination.

33.2. Only national federations are entitled to nominate candidates for this examination

Applications must be accompanied by a fee of 20 Euros per candidate.

33.3. The candidates shall have at least five (5) years experience as a 'National Official' related to the discipline concerned. Their names are to be sent to the ICF Headquarters and to the Chairperson of the Committee concerned at least two months before the date of the examination.

33.4. A sub-committee of the ICF consisting of three members, who are to be chosen from time to time, will hold this examination in conjunction with World Championships. The examination will be carried out in one of the three official ICF languages and will be based on the knowledge of the ICF Statutes, the ICF discipline related rules and practical competition experience.

33.5. If a National Federation requests an examination at a time other than a World Championships, the Federation concerned is responsible for all travel and subsistence costs for the examiners.

33.6. Successful candidates will be issued an International Official's card discipline related for a period of four (4) years.

33.7. The card can be renewed for further periods of four years if the National Federation of the cardholder sends this card to the Chairperson of the ICF Canoe Polo Committee within two (2) months of the expiry date. The Officials' Card

expires, is lost or destroyed a 20 euro fee for renewal will be charged.

33.8 Candidates, who have failed one examination, can enrol for another examination, but not earlier than the following year.

34. INTERNATIONAL CANOE POLO REFEREES

[TR]

34.1 Games of International competitions must be refereed by at least one referee who is an accredited referee in possession of a valid International Canoe Polo Referee card.

34.2 The ICF Canoe Polo Committee gives recognition as an International Canoe Polo Referee to those persons who have passed an appropriate examination.

34.3 Only national federations are entitled to nominate candidates for this examination. The fee of 20 Euros can be accompanied by the application or can be paid at the start of the examination to the examination committee.

34.4 The candidates shall have at least three (3) years experience as a 'National Canoe Polo Referee' in their Federations main competition. Their names are to be sent to the Chairperson of the ICF Canoe Polo Committee at least two months before the date of the examination.

34.5 A sub-committee of the ICF consisting of three members, who are to be chosen from time to time, will hold this examination in conjunction with International Canoe Polo Competitions. The examination will be carried out in one of the three official ICF languages and will be based on the knowledge of the ICF Canoe Polo Rules and practical refereeing experience.

34.6 If a National Federation is asking for an examination at another date, the Federation concerned will cover the travel and subsistence costs of the examiners.

34.7 Successful candidates will be issued with a valid card as an International Canoe Polo Referee for a period of four years.

34.8 The card can only be renewed for another period of four years if the National Federation of the cardholder sends this card to the Chairperson of the ICF Canoe Polo Committee. This must be done within two (2) months of the expiry date. The referee must also have received three positive assessments by International Canoe Polo Referee assessors during the preceding year.

34.9 Candidates, who have failed one examination, can enrol for another examination, but not earlier than the following year.

CHAPTER III - GAME REGULATIONS

35. PLAYING AREA

[TR]

35.1 The playing area shall be rectangular, and have a length of thirty-five (35) metres and a width of twenty-three (23) metres. The Immediate-Surround of the playing area shall be an unobstructed area of water, with where possible a minimum width of one metre outside all boundaries.

35.2 The water throughout the playing area must be still water at least ninety (90) centimetres deep.

35.3 There must be a clear height of at least three (3) metres without obstacles, and a minimum ceiling height of five (5) metres, above the playing area.

35.4 There shall be a walkway on each side of the playing area kept clear for the referees.

36. PLAYING AREA BOUNDARIES AND MARKERS

[TR]

36.1 The longer boundaries are to be referred to as the sidelines, the shorter boundaries as the goal lines.

36.2 The sidelines and goal lines are to be indicated by a floating lane rope. The section of the goal line four (4) metres either side of the centre of the goal frame should be free from floats so as not to interfere with the positioning of the goalkeeper.

36.3 Markers indicating the goal lines, half way line and points six (6) metres from each goal line are to be placed along the sidelines, and be clearly visible to both referees and players.

36.4 Markers indicating the substitute-areas are to be placed on the goal lines four metres either side of the centre of the goal frame, and be clearly visible to both referees and players.

37. GOALS

[TR]

37.1 Each goal will be located over the centre of each goal line with their lower inside edge two (2) metres above the surface of the water. Each goal is to be held in such a way that it is prevented from swinging or moving. The goal supports should not interfere with any player defending or manoeuvring around the goal area, or with the flight of the ball in the area of play.

37.2 Each goal will consist of an open frames one (1) metre high by one and a half (1.5) metres wide (measured internally) hung vertically. The maximum width of a material used to construct the goal frame will be five (5) centimetres. The goal frames should not have any vertical or horizontal bars parallel to the main goal frame which may cause the ball to rebound out of the goal frame. The front face of the frame must be free from any loose netting, net fastenings or sharp edges which may impede the flight of the ball or damage the ball or players equipment. The front face of The frame must be red and white striped- each stripe being of 20 centimetres length. For venues involving multiple fields all goals must be identical.

37.3 Each goal is to have a net made from a strong shock absorbing material, which allows the ball to pass freely through the goal frame but indicate clearly that a goal has been scored. The net shall be a minimum of fifty (50) centimetres deep and have no loose or hanging ends which may interfere with players or their equipment or blow in the wind or that may impede the ball entering the goal.

38. THE BALL

[TR]

38.1 The ball shall be round and shall have an air chamber with a self-closing valve. It shall be waterproof, without external strapping or any covering of grease or similar substance.

38.2 The weight of the ball shall be not less than four hundred (400) grams and not more than four hundred and fifty (450) grams.

38.3 For games played by Men, Under-21 Men and Master Men, the circumference of the ball shall not be less than sixty-eight (68) and not more than seventy-

one (71) centimetres, and its pressure shall be 90-97 kPa (kilo pascals).

38.4 For games played by Women, Under-21 Women and Master Women, the circumference of the ball shall not be less than sixty-five (65) and not more than sixty-seven (67) centimetres, and its pressure shall be 83-90 kPa (kilo pascals).

39. GAME OFFICIALS

[TR]

39.1 The game officials shall consist of two (2) referees, two (2) goal line judges, one (1) scrutineer, two (2) timekeepers and one (1) scorekeeper.

39.1.1. Depending on the degree of importance games can be controlled by teams of between three (3) and eight (8) officials. Where there are only three (3) game officials, two (2) shall be the referees who shall take on the additional duties of the goal line judges and the scrutineer and one timekeeper taking over the duties of the timekeepers and scorekeeper.

40. REFEREES

[TR]

40.1 The referees shall be in absolute control of the game. Their authority over the players shall be effective during the whole time that they and the players are within the competition area.

40.2 All decisions of the referees on questions of fact shall be final and their interpretation of the rules shall be obeyed throughout the game. No protest or appeal can be made in relation to an interpretive decision of a referee. The referees shall not make any presumption as to the facts of any situation during the game but shall interpret what they observe to the best of their ability.

40.3 The referees shall whistle to start and restart the game and to declare goals, goal line throws, corner throws, infringements of the rules and time-outs. A referee may alter their decision provided they do so before the ball is put back into play. The referee must ensure that before the game is restarted that in their sole discretion neither team is disadvantaged.

40.4 The referees shall have the power to order the removal from the competition area any person whose behaviour prevents the referees from carrying out their duties in a proper and impartial manner.

40.5 The referees shall have the power to abandon the game at any time if, in their opinion, the behaviour of the players, team-officials or other circumstances prevent it from being brought to a proper conclusion. If the game has to be abandoned the referees shall report their actions to the Chief Official.

40.6 Where the referees cannot agree on a decision the first named referee will take the final decision.

40.7 If either referee is unable to continue to referee a game due to injury, illness or other reason, the Chief Referee will replace that referee with a suitably qualified replacement.

41. GOAL LINE JUDGES

[TR]

41.1 The goal line judges shall be situated diagonally opposite each other on the left-hand side of each referee.

41.2 The duties of the goal line judges shall be to signal until acknowledged by the referee by:

41.2.1 Raising a green flag when the players are correctly positioned on their respective goal lines at the start of a period;

41.2.2 Raising a red flag to indicate the ball is out of play by crossing the goal line. (Goal line-throw, corner-throw, goal);

41.2.3 Waving a red flag for an improper start or restart;

41.2.4 Waving a red flag for an improper re-entry of an excluded player or improper entry of a substitute.

41.3 Pointing both the red and green flag at the goal when the ball enters the goal frame.

41.3.1 Each goal line judge shall be provided by the organising committee with a supply of balls of the correct size. When the original ball has gone outside the field of play, they shall throw a new ball, when directed by the referee, to the goalkeeper (for a goal

throw) or to the nearest player of the attacking team (for a corner throw).

42. SCRUTINEER

[TR]

42.1 The scrutineer will be responsible for checking the equipment of all players before and during their game. They may also check equipment at any other time during a competition.

43. TIMEKEEPERS

[TR]

43.1 The timekeepers shall be situated at the official's table.

43.2 The duties of the timekeepers shall be to:

43.2.1 Record the exact periods of playing time, timeouts and the intervals between the periods;

43.2.2 Control the periods of time-outs and to signal the period by raising a red flag, except that a referee shall signal the end of a time-out;

43.2.3 Record the send-off times of players ordered from the playing area in accordance with the rules, together with the re-entry times of such players or their substitutes;

43.2.4 Control the periods of exclusion of players and to signal the end of the period of exclusion by a visual electronic device or by raising and waving a green flag;

43.3 A timekeeper shall signal by any means provided it is distinctive, acoustically efficient and readily understood, the end of each period independently of the referees and their signal shall take immediate effect except in the case of the simultaneous award by a referee of a goal penalty shot, in which event the goal penalty shot shall be taken in accordance with the rules;

43.3.1 The first timekeepers shall perform the duties stated in 43.2.1 and 43.2.2 and the second timekeeper shall perform 43.2.3 and 43.2.4.

44. SCOREKEEPER

[TR]

44.1 The scorekeeper shall be situated at the official table.

44.2 The duties of the scorekeeper shall be to:

44.2.1 Record the awarded goals and maintain the scoreboard during the game;

44.2.2 Maintain the record of the game, including the players, the score, time-outs, green, yellow and red cards awarded against each player.

45. NUMBER OF PLAYERS

[TR]

45.1 Each team may consist of a maximum of eight (8) players for any one game. No more than five (5) players are permitted on the playing area at any one time. Any other players at that moment are to be considered as substitutes. A team must begin each game with five (5) players, ready to start on their own goal line. If a team is reduced to two (2) players at any time the referee shall end the game and refer the matter to the competition committee who shall decide the appropriate action to be taken.

45.2 The list of players names and numbers for a game must be handed to the appropriate official before the time indicated by the Competition Committee.

46. CHOICE OF END

[TR]

46.1 The first named team on the game sheet will start on the goal line at the left-hand side of the official table unless one of the captains or the Chief Official request a toss of a coin to determine the choice of ends.

47. IDENTIFICATION

[TR]

47.1 All players of the same team must have kayaks with decks of the same colour, spray decks of the same colour, outmost body covering of the same colour, helmets of the same colour and shirts of the same colour.

47.2 If the referee or scrutineer determines there is inadequate distinction between the teams, the first named team on the game sheet will be required to change their body identification colours.

47.3 The players of a team shall each be numbered from 1 to 99. This number shall be displayed on the body covering and on the helmet. Players may choose to have their family name on the rear of their body covering. This family name may be above or below their number but must be in the same position for the whole team.

47.4 The numbers will be clearly legible to the referees from anywhere on the field and must clearly individually identify each player in a team. A number at least 20 cm high must be on the back of the body. A number at least 10 cm height must be on the front of the body. Numbers at least 7.5 cm high must be on each side of the helmet. The captain of each team shall be distinguished from the rest of the team by an armband.

48. KAYAKS

[TR]

48.1

- Only Kayaks approved by the scrutineer may be used.
- Unregistered or illegal copies of designs registered under the ICF manufacturers scheme may not be used in ICF events and will automatically fail scrutineering. When there is a dispute over the legality of a design an independent panel of at least 3 people will assess the design in question and determine if it is a copy or not. If it is found to be an unregistered copy it will fail scrutineering and therefore will not be able to be used in the competition. The original designer and the ICF will be immediately notified.
- For full specifications on kayaks and padding - see appendix Scrutineering.

49. PADDLES

[TR]

49.1 Double-bladed paddles approved by the scrutineer may be used.

For full specifications on paddles - see appendix Scrutineering.

50. PERSONAL EQUIPMENT

[TR]

50.1 Each player must wear one helmet with facemask, approved by the scrutineer.

For full specifications on helmet and facemasks - see appendix Scrutineering.

50.2 Body protection, approved by the scrutineer, must be worn.

For full specifications on body protection - see appendix Scrutineering.

50.3 A shirt with sleeves, which at least covers the mid upper arm, must be worn. The players shall not have grease, oil or any similar substance on their arms and neck.

50.4 Beside the equipment and clothing listed above, personal clothing and effects, and a spray deck for the player is permitted. Extra protective equipment on the hands, forearm and elbows is permitted provided it is firm fitting, securely attached and with no sharp edges such that they do not endanger any other player. No other equipment is permitted. A player must not wear any items (such as jewellery) that can endanger either the wearer or any other player.

50.5 Players may not apply any greasy substances to their equipment.

51. TRADE-MARKS AND ADVERTISING SYMBOLS

[TR]

51.1 Kayaks, accessories and sportswear may carry trademarks, advertising symbols, and words.

51.2 Any trademarks, advertising symbols and words should be placed in such a way that it does not interfere with competitors identification and does not affect the outcome of the race or game.

51.3 The advertising of tobacco smoking and strong spirit drinks will not be accepted.

52. EXCHANGING EQUIPMENT

[TR]

52.1 Each player is permitted to leave the playing area and exchange any piece of equipment, at any time

during the game, provided the equipment has been approved by the scrutineer. The player concerned must collect equipment being exchanged from their substitutes area.

53. SCRUTINEERING

[TR]

53.1 Players' equipment is subject to scrutineering before, during or after a game.

A referee must dismiss from the playing area, once aware of the infringement, any player whose equipment is in breach of the rules, either at the first break in play or direct if the equipment has become dangerous for the players.

54. PLAYING TIME

[TR]

54.1 Playing time shall normally be two (2) periods each of ten (10) minutes duration, unless overtime is needed to decide the result. The minimum playing time will be two periods of seven (7) minutes.

54.2 The half time interval shall normally be three (3) minutes. The minimum half time interval will be one (1) minute.

54.3 The teams shall change ends after each period of play.

54.4 The referee may call time-out during the playing time. The timekeeper will stop the clock when the referee signals for time-out and restart the clock when the referee restarts the game with a whistle.

55. TIME-OUT

[TR]

55.1 The referee shall use a triple whistle to stop the game for time-out, except when a goal is scored in which case a long whistle blast will be used.

55.2 Time-out must be given if a capsized player or their equipment is interfering with play.

55.3 Time-out should be used immediately when game regulations are dangerously breached or if field equipment needs correction or adjustment (for

example: endangering another player due to a broken paddle).

55.4 Time-out should be used if any injury has occurred, or a player is illegally on the field, provided this does not disadvantage the other team.

55.5 Time-out must be used after a goal is scored, or a goal-penalty-shot is awarded or for any other incidences at the discretion of the referee.

55.6 If the referee has stopped the game, not during a break in play and where neither team was at fault (e.g. referee error, faulty goals, injury) the play will be restarted with a free throw to the team that last had possession. Where time-out was given for a capsized player the opposition is given a free throw to restart.

If the referee cannot determine who had possession at the time of the whistle, the referee will restart the game with a referee's ball. Signal 8 applies.

56. COMMENCEMENT OF PLAY [TR]

56.1 At the beginning of each period of play, five (5) players from each team line up ready to start, stationary and with some part of their kayaks on their own goal line. If the team deliberately causes an unnecessary delay a start infringement will be called. Signal 1, 15 and 17 (team warning) apply.

56.2 If a team has insufficient players to start the game 5 minutes after the programmed start time the game will be declared a forfeit and referred to the competition committee. Signal 2 applies.

56.3 The referee blows the whistle to start play and then releases or throws the ball into the centre of the playing area.

56.4 If the ball is released or thrown giving one team definite advantage, the referee calls for the ball and restarts the period of play.

56.5 Physical assistance from other players is not allowed on the player attempting for the ball. Infringement incurs a free throw. Signals 1 and 14 apply.

56.6 Only one player from each team may make an attempt to gain possession of the ball. Any other player that accompanies the player attempting for the ball

must not be within a radius of three (3) metres from the body of the player attempting for the ball. Infringement incurs a free throw. Signals 1 and 14 apply.

57. BALL OUT OF PLAY

[TR]

57.1 Sideline and overhead obstacle: When any part of the ball touches the physical sideline or the vertical plane of the physical sideline, or touches any overhead obstacle, the team that was not the last to touch it with their paddle, kayak or person is awarded a sideline-throw.

57.1.1. If the physical sideline is moved out of position as a consequence of normal play, the boundary including the vertical plane above moves with it. Signals 5 and 14 apply.

57.1.2. Sideline throw: The player taking the throw must position their kayak at the point of exit of the ball, or the point on the sideline nearest to the point of contact with an overhead obstacle.

57.2 Goal line throw: The goal line is always measured by the vertical plane of the goal frame in all situations even if the goal frame or the physical goal line are moved out of position as a consequence of normal play. A goal line or corner throw will be awarded when any part of the ball touches the vertical plane of the front of the goal frame except where a ball rebounds off the goal frame (not the goal supports) into the playing area, or where the ball is prevented from completely entering the goal by a defenders paddle and rebounds back into the field of play, or where a goal is scored.

57.2.1 Goal line throw: When the ball goes out over the teams own goal line and has been last touched by the other team then a goal line throw will be awarded. Signals 6 and 14 apply. The player taking the throw must be positioned with their kayak on the goal line.

57.3 Corner-throw: When the ball goes out over the teams own goal line and was last touched by their own team then a corner throw will be awarded. Signals 5 and 14 apply. The player taking the throw must be positioned with their kayak in the corner of the playing area.

58. SCORING A GOAL

[TR]

58.1 A team scores a goal when the whole of the ball passes through the plane of the front of the goal frame of their opponent's goal. If a goal is not rigidly fixed, and moves the ball must go through the goal frame. The referee will indicate the number of the player scoring the goal to the scorekeeper. Signal 3 applies and one long whistle blast by the referee. Time-out must be used after a goal is scored.

58.2 If the ball is prevented from entering a goal by either a defender's or substitutes paddle that enters the goal from behind, then a goal is awarded.

59. RESTART AFTER GOAL

[TR]

59.1 After a goal is scored, the team that conceded the goal takes the restart throw. The player taking the throw must position part of their kayak in the centre of the playing area. The referee blows the whistle to restart play. The player is not required to hold the ball above their head.

59.2 All other players must be positioned with their bodies in the other half of the playing area until play restarts.

60. CAPSIZED PLAYER

[TR]

60.1 If a player capsizes and leaves their kayak, the player may not take any further part in the play and must leave the playing area immediately, with all of their equipment. If a player who has capsized wishes to rejoin the game the player must do so according to the rules of entry to the field of play. No person may enter the playing area to assist a player with their equipment, and no-one may obstruct the referee while assisting a player. A team may be penalised during a game for any illegal outside assistance, or for any interference with the opposition that constitutes outside assistance. The referee to determine the severity of the sanction.

61. ENTRY TO THE PLAYING AREA, RE-ENTRY, SUBSTITUTION AND EXCHANGING EQUIPMENT

[TR]

61.1 No more than the legally allowed number of players from a team may be on the playing area at any one time.

61.2 Substitutes must wait in their own substitute's area.

61.3 Substitution is allowed at any time including during time outs. Exit and entry of players for substitution may be anywhere along the teams own goal line provided all of the player's kayak and equipment has left the playing area before the substitute may enter the playing area. A player leaving the playing area solely as part of the action of the game is not subject to the conditions for re-entry.

61.4 A capsized player who has not left the playing area at their goal line may be substituted not earlier than the next break in play. All of the capsized players equipment (for example kayak and paddle) must be removed from the playing area before a substitution is allowed.

61.5 Each player is permitted to leave the playing area and exchange any piece of equipment, at any time during the game, provided the equipment has been approved by the Scrutineer. The player concerned must collect equipment being exchanged from their substitute's area.

62. ILLEGAL SUBSTITUTION AND ENTRY TO THE PLAYING AREA

[TR]

62.1 Where more than the legally allowed number of players from a team are in the playing area at any one time the player(s) coming illegally into the playing area should be given a yellow card(s). If it is not clear which player(s) should exit the playing area then the team's captain must nominate a player(s). Infringement incurs a sanction. Signals 7 and 14 apply.

62.2 When a substitute places their paddle in the playing area to prevent a goal from being scored, a goal penalty shot is awarded. The offending player is

penalised with a red card. Infringement incurs a sanction. Signals 16 and 7 apply

63. ILLEGAL USE OF THE PADDLE

[TR]

Signals 12 and 15 apply. The following are defined as illegal use of the paddle.

63.1 Contacting an opponent's person.

63.2 Playing, or attempting to play, the ball with a paddle when the ball is within arms reach of an opponent, and that opponent is attempting to play the ball with their hand.

63.3 Playing or attempting to play the ball with a paddle across the bow of an opponent's kayak, within arms reach of the opponent in a normal paddling position.

63.4 Placing a paddle within arms reach of an opponent who has the ball in their hand. A goalkeeper is excluded from this rule and is allowed to directly defend against a shot at goal as long as the paddle is not moved towards the opponent at the time of the shot and it does not result in significant contact with the opponent.

63.5 When a player, with their paddle, attempts to restrict an opponent using their paddle.

63.6 Playing an opponents paddle instead of the ball.

63.7 Throwing a paddle.

63.8 Any other use of a paddle that endangers a player.

64. ILLEGAL POSSESION

[TR]

64.1 Signals 11 and 15 apply. A player is in possession of the ball when they have the ball in their hand or are in a position to reach the ball with their hand, the ball being on the water and not in the air. A player balancing the ball on their paddle will also be considered to be in possession.

64.2 A player must dispose of the ball within five (5) seconds of gaining possession, either by passing it to another player or by performing one throw causing the

ball to travel by at least one metre measured horizontally from the point of release.

64.3 If a player shares possession with another player or the ball moves out of arms reach whilst being tackled, the five (5) seconds shall begin again once a player has regained possession.

64.4 A player who capsizes to the point of the whole of their body and head going under water is considered to have lost possession if they do not have the ball in their hand(s).

64.5 A player may not manoeuvre their kayak with their hands or paddle while the ball is resting on their spray deck.

65. ILLEGAL HAND TACKLE

[TR]

Signals 10 and 15 apply. A Hand-Tackle is a player pushing an opponent with one (1) hand. The following hand-tackles are illegal:

65.1 Any hand-tackle where the tackled player does not have possession of the ball or is sharing possession of the ball with another player.

65.2 Any body contact other than one open hand to the opponents' back, upper arm or side.

65.3 Any hand-tackle, which endangers the tackled player.

66. ILLEGAL KAYAK TACKLE

[TR]

Signals 10 and 15 apply. A kayak-tackle is a player manoeuvring their kayak against an opponent's kayak in an attempt to gain possession of the ball. The following kayak-tackles are illegal.

66.1 Any kayak-tackle that results in significant contact between the tackler's kayak and the head or body of an opposing player, or endangering a player. The player's arm shall not be considered to be part of the body when any part of it is elevated away from the body.

66.2 Any deliberate kayak-tackle that results in significant or continuous contact with the opponent's spray deck or where the tackler continues to tackle into

or over the spray deck. After a kayak tackle, when the ball is no longer in possession of either player, they may move off each others kayaks by using their hands in a controlled action.

66.3 A player in possession of the ball who fails to avoid significant contact between the bow of his kayak and the head or body of the opponent.

66.4 Any hard tackle, that results in significant contact to the side of the kayak, at an angle between eighty (80) and one hundred (100) degrees.

66.5 Tackling an opponent who is not within three (3) metres of the ball.

66.6 Tackling an opponent when the tackler is not competing for the ball.

67. ILLEGAL JOSTLE

[TR]

67.1 Signals 10 and 15 apply. A jostle is a player manoeuvring their kayak against an opponent's kayak between the six (6) metre line and the goal line, at the attacking end of the field, to gain a position. The following jostling is illegal.

67.2 When a player is stationary or attempting to maintain a position and their body is moved by more than half a metre by sustained contact from an opponent's kayak.

67.3 When the contact to the opponent's kayak would be defined as an illegal kayak tackle under any section of rule 66.

67.4 When the body of the jostled player is behind the goal line.

68. ILLEGAL OBSTRUCTION

[TR]

Signals 9 and 15 apply. The following obstruction is illegal:

68.1 A player actively or deliberately impeding the progress of an opponent when neither player is within three (3) metres of the ball except where the players are jostling for position at the attacking end of the field as covered in rule 67. Note: A player is considered to be

actively impeding the progress of an opponent when their kayak is moving or they are attempting active paddle strokes.

68.2 A player who is not competing for the ball who actively impedes the progress of an opponent who is competing for the ball on the water and not in the air.

69. ILLEGAL HOLDING

[TR]

Signals 9 and 15 apply. The following holding is illegal:

69.1 A player gaining support or propulsion by placing their hand, arm, body or paddle on an opponent's kayak, or holding the opposing player or their equipment.

69.2 A player using for propulsion or support, or moving out of place, any playing area equipment e.g. boundary markers, goal supports, or any surrounding object.

69.3 A player using their paddle to lift, pull or hold an opponents kayak while jostling for position in the six metre area, or attempting a kayak or hand tackle.

69.4 A player fending off an opponents attempted hand or kayak tackle with their hand or forearm, or with the movement of the elbow towards their opponent.

69.5 A player using a forceful action with one or both hands that results in significant contact with the opponent's arm, or with the ball that is still in contact with the opponent's hand.

70. UNSPORTING BEHAVIOUR

[TR]

Signal 17 with a green card applies. The following is defined as unsporting behaviour:

70.1 Any infringement committed by a player during a break in play.

70.2 Hindering another player's attempt at righting themselves after capsizing. A player who is upside down must be allowed to get their head and both shoulders above the water before an opponent is allowed to attempt another tackle.

70.3 Interference with the equipment of an opponent. Such as holding or moving another player's paddle out of their reach, or deliberately preventing the player from regaining possession of the paddle.

70.4 Use of deliberate delaying tactics. Such as throwing the ball away, or deliberately obstructing the opposition, to delay a quick restart after an infringement. When a team is penalised, any player on that team who has possession of the ball must immediately place the ball on the water and not impede or delay the opposition in any way from taking a quick restart.

70.5 Players showing dissent.

70.6 Retaliation.

70.7 Foul or abusive language.

70.8 Other unsporting behaviour to a player, referee or other official or behaviour considered detrimental to the game, at the discretion of the referee.

70.9 Bouncing the ball out of play off an opponent's kayak to gain advantage.

71. DEFENCE OF GOAL

[TR]

71.1 The one defending player most directly under the goal, in order to defend the goal with the paddle is considered to be the goalkeeper at that time. The goalkeeper's body must be facing into the playing area and attempting to maintain a position within one metre of the centre of the goal line. If two or more players are directly under the goal, the player most directly under the goal is considered the goalkeeper at that time.

71.2 If the goalkeeper is not in possession of the ball and is moved or unbalanced by contact from an opposing player, then that player has committed an illegal tackle. Infringement incurs a sanction. Signals 10 and 15 apply.

71.3 If an attacker moves the goalkeeper by pushing a defender into the goalkeeper, where none of the defenders have possession of the ball, the attacker shall be penalised. If the defender has an opportunity to

avoid contact with the goalkeeper after being pushed, but does not, the attacker will not be penalised.

71.4 If a defender pushes the attacker onto the goalkeeper, then the attacker should not be penalised. If the attacker has an opportunity to avoid contact with the goalkeeper after being pushed, but does not, the attacker will be penalised.

71.5 If an attacker, in possession of the ball, whose original direction or speed would not have led to contact with the goalkeeper is pushed onto the goalkeeper by a defender, the attacker will not be penalised.

71.6 A goalkeeper who is not in possession of the ball, but is attempting for the ball on the water, can be tackled like any other player. If the goalkeeper does not gain possession they will not regain goalkeeper status until the attacker has shot or passed the ball. After the attacker loses possession of the ball, the attacker must not actively impede the goalkeeper's attempt to regain or maintain their position.

71.7 Within the six (6) metre area, an attacker must not actively prevent a defender from taking the position as goalkeeper. A defender will be allowed to push an attacker with the kayak, in order to take the position of goalkeeper without penalty, unless dangerous play is used.

71.8 As soon as a team has control of the ball they can no longer be considered to be defending and thus cannot have a player defined as a goalkeeper.

72. REFEREE'S BALL

[TR]

72.1 A referee's ball will be declared when two or more players of opposing teams have one or more hands firmly on the ball, so that the players share possession of the ball for five (5) seconds. If initial contact is made directly with the ball illegal holding will only apply if either player uses the opposition for support.

72.2 If the referee needs to stop the game, not during a break in play and where neither team is at fault (e.g. referee error, faulty goals, injury) and the referee cannot determine who had possession at the time of the

whistle, the referee will restart the game with a referee's ball.

72.3 A referee's ball will be taken at the nearest point on the sideline to the incident. Where a referee's ball is awarded for an incident that occurs between the six (6) metre line and the goal line, the referee's ball will be held at the nearest six (6) metre line. Signal 8 and Time-out applies.

72.4 Two opposing players will line up at right angles to the sideline, on the side nearest their own goal line, near to the sideline where the situation occurred, one metre apart facing the referee. They will place their paddles on the water, but not between their kayaks and their hands on the deck of the kayak or on their paddle.

72.5 All other players must be at least three (3) metres away from the point between the two players participating in the referee's ball.

72.6 The referee will throw the ball on the water between the players and blow the whistle to restart play. Both players must make an attempt for the ball with their hands as soon as it touches the water. The players must not play the ball before it hits the water. Infringement incurs a sanction. Signals 11 and 15 apply.

73. ADVANTAGE

[TR]

73.1 The referees can play advantage when an infringement occurs as long as neither has blown their whistle. The referees should play advantage if the team that was infringed upon is more benefited by play continuing. When playing advantage, the referees should recognise the illegal play by signalling and calling 'play on'. Signals 13 and 14 apply.

73.2 The referee can penalise any player who causes an infringement for which advantage is played at the next break in play with a green, yellow or red card.

73.3 When playing advantage, the next pass or shot should be completed and if there is no clear advantage, the original infringement should be called and appropriate sanction(s) and signals given. The referee is to indicate where the sanction should be taken.

The referee can impose any combination of the following sanctions for illegal-play depending on the severity and/or frequency of offences being penalised. The sanctions available to the referees are Free Throws, Free Shots, Goal Penalty Shots, Warnings, Yellow Card Send Off and Red Card Send Off. The following definitions should be used when determining which sanction to impose:

- a) Deliberate Foul: a foul where no effort was made to avoid the illegal play.
- b) Dangerous Foul: is significant contact with the opponent's arm, head or body that may result in personal injury and is illegal.
- c) Significant contact: any hard contact that may result in equipment damage or personal injury.
- d) The act of passing or shooting: begins when a player has the ball in their hand, or balancing on their paddle, and is clearly attempting to pass the ball to a team mate, or shoot at goal.
- e) A Near Certain Goal: The referee must be certain that a goal was the most likely end result if play had continued.
- f) Control of the ball: A player is considered to have control of the ball if that player is in possession of the ball, or is the nearest player to the ball and is within 3 metres of the ball on the water.
- g) Team Possession: a team is considered to have team possession and therefore be the attacking team if any member of that team has possession or control of the ball.

74.1 Goal-penalty-shot. Signal 16 and time out applies.

74.1.1. Inside the six (6) metre area, a goal-penalty-shot will be awarded for any deliberate or dangerous foul on a player in the act of shooting.

74.1.2. Inside the six (6) metre area, a goal-penalty-shot will be awarded for any deliberate or dangerous foul on a player in the act of passing or positioning for a near-certain goal.

74.1.3. Inside the six (6) metre area, a goal penalty shot will be awarded for a deliberate or dangerous foul on a player who is attempting to take a free shot.

74.1.4. Outside the six (6) metre area, a goal-penalty-shot will be awarded for any deliberate or dangerous foul on a player in the act of shooting for a near-certain goal while the goal is not defended.

74.1.5. Outside the six (6) metre area, a goal-penalty-shot will be awarded for any deliberate or dangerous foul on a player in the act of passing or positioning for a near-certain goal while the goal is not defended.

74.2 Free shot. Signal 15 applies. A Free Shot may be a direct shot at goal.

74.2.1A free shot will be awarded for any foul on a player unless a goal penalty shot is awarded.

74.3 Free throw. Signal 14 applies. A Free Throw may not be a direct shot at goal.

74.3.1 A free throw will be awarded for any ball out of play, or when a goal penalty shot or free shot has not been awarded.

74.3.2 A free throw must not be a direct shot at goal. Infringement incurs a sanction and the opposition is awarded a free throw. Signals 11 and 14 apply. Side line throws, goal line throws, corner throws and centre restarts are considered to be free throws and may not be direct at goal.

74.4 Red Card: A player, team coach or team official is sent off for the rest of the game and may not be replaced. Signal 17 with Red card applies.

74.4.1 A red card will be awarded to a player receiving a second yellow card for any reason or where a yellow card is disputed.

74.4.2 A red card should be awarded to a team coach or team official when a green card is disputed or has not had the desired effect of causing the person to control their play or attitude.

74.4.3 A red card should be awarded if a personal attack on a player occurs.

74.4.4 A red card should be awarded for a deliberate or dangerous foul, that in the referee's opinion is of major influence to the game, irrespective of any other sanction awarded.

74.4.5 A player, team coach or team official receiving a red card during a competition will automatically receive a one game suspension, and be unable to take part in the next game in that competition.

74.4.6 A player, team coach or team official receiving a red card during a competition may be referred to the competition committee for further disciplinary action by either referee if they feel further action or sanctions are necessary.

74.5 Yellow Card: A player is sent off for two (2) minutes and must not be replaced. Timing of the send off is suspended for periods of time out or between periods of play. Signal 17 with Yellow card applies.

74.5.1 A yellow card will be awarded to a player receiving an individual green card for any reason which results in that player having a total of 3 green card including team warnings.

74.5.2 A yellow card will be awarded for a deliberate or dangerous foul on a player that prevents the scoring of a near certain goal, except where the referee feels that the awarding of a goal penalty shot is sufficient sanction.

74.5.3 A yellow card will be awarded for a foul that the referee considers both deliberate and dangerous unless a red card is awarded.

74.5.4 A yellow card will be awarded for a deliberate or dangerous foul that is repeated, or after a green card or team warning has already been awarded to that player or their team for the same offence.

74.5.5 A yellow card will be awarded for repeated and continuous disputing of referee's decisions.

74.5.6 A yellow card will be awarded for foul or abusive language directed at an opponent or official.

74.5.7 Players sent off must obey the rules of entry to the playing area for re-entry at the completion of the send-off period.

74.6 Green Card Warning: designed to warn a player, team coach or team official to control their play **or** behaviour or risk a yellow card, or red card send off if the infringement(s) continue. Signal 17 with green card applies.

74.6.1 A green card warning will be awarded for any deliberate or dangerous foul except where a yellow or red card is awarded.

74.6.2 A green card will be awarded to a player, team coach or team official for unnecessary verbal communication directed at a referee, official or opponent, or any other unsporting behaviour except where a yellow or red card is awarded.

74.6.3 A green card will be awarded to a team coach or team official if they leave the coaches area during play.

74.7 Team Warning.

Signal 17 with a green card applies. A team warning occurs when a referee awards a green card to all players on a team.

74.7.1 A team warning will be awarded to a team by either referee if more than 1 player on the same team are guilty of the same deliberate or dangerous foul.

74.7.2 A team warning will be awarded to a team by either referee if more than 1 player on the same team are guilty of unnecessary verbal communication directed at a referee, official or opponent, or any other unsporting behaviour that is repeated by more than 1 player of the same team.

74.7.3 After a team warning has been given for a particular infringement, a yellow card will be awarded to any player of that team for any subsequent deliberate or dangerous infringement for the same offence.

75. TAKING THROWS

[TR]

75.1 The player taking any goal line throw, corner throw, sideline throw, free throw or free shot must be in the correct position and stationary before taking the throw. The player must clearly hold the ball stationary for a moment above shoulder level to indicate they are taking the throw. The players initial throw must travel one metre measured horizontally from point of release or change possession to another player of the same team. Infringement incurs a sanction with the opposing team being awarded possession of the ball. Signals 11 and 14 apply.

75.2 When taking any free throw, or free shot, the player taking the free throw or free shot must be allowed to take up their position to take the throw. No opponent may prevent the player taking up their position or contact the player or their equipment, **or** deliberately prevent or restrict the movement of the player taking the throw until the ball is back in play. Infringement occurs a sanction Signals 11 and 15 or 16 apply.

75.3 The ball is not in play until it has travelled one (1) metre measured horizontally from point of release or changed possession to another player of the same team. The opposition must not attempt to prevent the ball from travelling one metre measured horizontally or changing possession. Infringement incurs a sanction. Signals 11 and 15 or 16 apply. The only exception will be for Free Shots awarded within 2 metres of the goal: Defenders (including the goal keeper) will be allowed to block the free shot after release, but before it has travelled 1 metre from the point of release, with a stationary paddle or stationary hand(s). All defender's 75.4 paddles and hands must be kept out of arms reach and any movement towards the player taking the free shot by either a paddle or hand(s), or blocking the ball before it has been released will be deemed a deliberate action and result in a goal penalty shot being awarded.

75.5 The player must throw the ball within five (5) seconds of being in possession and in a position to take the throw. The five seconds for the restart applies from when any member of the team is in a position to pick up the ball and take the throw. Any dropping or fumbling of the ball will not be considered, provided the initial throw is taken within the five seconds. Infringement incurs a sanction with the opposing team awarded possession of the ball. Signals 11 and 14 applies.

75.6 Following an infringement that led to the awarding of a free shot or free throw, the referee will indicate where the free shot or free throw will be taken. The free shot or free throw will be taken: either where the infringement occurred, or where the ball was at the time of the infringement, or where the ball landed if it was in flight at the time of the infringement, whichever most advantages the team receiving the sanction.

76. TAKING A GOAL PENALTY-SHOT [TR]

The player taking the goal penalty-shot will be stationary with their body on the six (6) metre line.

All other players must be positioned with their bodies in the other half of the playing area until play restarts.

The shot will be taken when referee blows the whistle. The five (5) second rule applies.

Play will restart on the whistle. No presentation of the ball is required.

The player taking the shot may not play the ball again until it has touched another player or another player's equipment or the goal frame.

77. COMPLETION OF PLAY [TR]

77.1 The timekeeper will indicate the end of the period of playing time by the use of a loud signal. The ball is dead at the start of the signal. The referee shall use signal 2 to confirm the timekeeper's signal.

77.2 If a goal penalty-shot has been awarded prior to the signal for completion of play, the goal penalty-shot must be taken before play is to be considered completed. In this situation, the ball shall after it has been thrown immediately be dead if it hits the water or the goal frame and comes back into the playing area.

78. OVERTIME [TR]

78.1 Overtime shall consist of consecutive periods of five (5) minutes each; with the team scoring the first goal deemed the winner. There shall be a three (3) minute break before overtime commences and a one (1) minute break between periods, with a change of ends.

79. PROTEST TO THE COMPETITION COMMITTEE [GR]

79.1 A delegation-leader or team-leader may lodge a protest in accordance with these rules. Such protests must be made to, and determined by, the Competition

Committee. The Competition Committee may permit a protest to be made by two or more delegation- or team-leaders jointly where in the Competition Committee's opinion their grievance arises out of the same decision.

79.2 Objections about scrutineering decisions may be made verbally without fee by a delegation-leader or team-leader to a Scrutineer or the Chief Scrutineer before or during a game in which the equipment is involved. If the objection is made before the game, the equipment may be re-scrutinised. If a scrutineering objection is made during a game the Scrutineer will make a decision as to whether the Referee should call the player in to have their equipment inspected.

79.3 All decisions of the referees on questions of fact shall be final and their interpretation of the rules shall be obeyed throughout the game. No protest can be made in relation to an interpretive decision of a referee.

79.4 Any protest must be made:

79.4.1 Within twenty (20) minutes after the game of the incident that resulted in the protest, and be accompanied by a fee of 25 Euros which will be refunded if the protest is upheld; or

79.4.2 Not later than one hour before the start of the game where the protest is against the right of a player or team to participate in a game, and be accompanied by a fee of 25 Euros which will be refunded if the protest is upheld.

79.5 The Team leader (or his/her representative) must make the notice of protest to the Chief Official in writing setting out:

79.5.1 The incident in question;

79.5.2 The grounds upon which the protest is made; and

79.5.3 The reasons or circumstances supporting the alleged grounds of protest.

79.6 Nothing in the rules prevents the withdrawal of a protest by a Team Leader at any time by writing to the Chief Official.

79.7 On receipt of a protest in accordance with the Rules, the Chief Official must immediately forward the

notice of protest and any accompanying documents to the Competition Committee.

79.8 The Competition Committee shall, as soon as practical after receiving a protest, investigate and consider the protest and shall within ten (10) minutes of receiving such notice determine whether:

79.8.1 The protest should be dismissed, because in its determination, the protest is trifling in nature or has no merit; or

79.8.2 The protest warrants further review and determination in accordance with these rules.

79.9 If the Competition Committee determines the matter warrants further review in accordance with these rules, it shall as soon as practicable, having regard to the proximity of relevant events, call a meeting of the Competition Committee.

79.10 When a protest is made against a player or a team, the team-leader of the player or team in question shall be presented with a copy of the protest to read.

79.11 The Competition Committee may conduct a meeting (or any adjournment it permits) in such manner as it sees fit, but shall:

79.11.1 Give to the protesting Team Leader the opportunity to be heard;

79.11.2 Give due consideration to any statement given by the protesting Team Leader and any relevant official;

79.11.3 Allow the protesting Team Leader to be present along with their representative;

79.11.4 May request or require the protesting Team Leader or any other witness to attend the meeting or provide such evidence as is available; and

79.11.5 Give the Team Leader (or their representatives) of any team that may be directly affected by the protest every opportunity to be heard.

79.12 Following consideration of all relevant and available information, the Competition Committee shall arrive at a finding. A decision of the Competition

Committee shall be by a majority decision. The Competition Committee may:

79.12.1 Disqualify a team, or exclude them from further competition;

79.12.2 Where eligibility protest against a team is upheld, disqualify the team from the competition. When a team is disqualified, insofar as is possible, the results of all previous games the team has played in the competition will be nullified or awarded to their opponents, as appropriate. Any awards of medals, trophies or placing will be rescinded.

79.12.3 Take such other action as it thinks fit and in each case shall give written reasons for its decision.

79.13 The Chief Official shall then immediately notify the protesting Team Leader and all other relevant people of the Competition Committee's decision in writing.

79.14 A protest made later - within 30 days from the date when the game in question was held - is only permitted if the officials of the association making the protest can prove that the facts on which the protest is based came to their attention following the conclusion of the competition. A late protest shall be referred to the Chairperson of the ICF Canoe Polo Committee and accompanied by a fee of 25 Euros that will be refunded if the protest is upheld.

80. DISCIPLINARY ACTION BY THE COMPETITION COMMITTEE

[TR]

80.1 The Competition Committee may summon any delegation member, to appear before a meeting of the Competition Committee convened in accordance with these Rules for the purpose of investigating a matter if in the opinion of the Competition Committee there is reason to believe that they have:

80.1.1. Failed to comply with any of the provisions of these Rules; or

80.1.2. Conducted them in a manner considered to be injurious or prejudicial to the character or interests of the Competition.

80.2 The Competition Committee may conduct a meeting (or any adjournment it permits) in such manner as it sees fit, but:

80.2.1 Shall give to the summoned delegation member every opportunity to be heard;

80.2.2 Shall give due consideration to any statement given by the summoned delegation member and any relevant official;

80.2.3 Shall allow the summoned delegation member to be present along with their representative; and

80.2.4 May request or require the summoned delegation member or any other witness to attend the meeting or provide such evidence as is available.

80.3 Following consideration of all relevant and available information, the Competition Committee shall arrive at a finding. A decision of the Competition Committee shall be by a majority decision. The Competition Committee may:

80.3.1 Reprimand a player;

80.3.2 Fine a delegation member or team;

80.3.4 Suspend an individual member from participating in part or all of the Competition;

80.3.5 Take such other action as it thinks fit and in each case shall give written reasons for its decision.

80.4 The Chief Official shall immediately notify the Team Leader of the summoned delegation member and all other relevant people of the Competition Committee's decision in writing.

CHAPTER IV - SPECIAL RULES FOR WORLD CHAMPIONSHIPS

Rules in this section, specifically for World Championships are in addition to, or to override, those in earlier sections. It is recommended that the majority of the rules in this section are used for Continental Championships, with any reference to the ICF substituted by the relevant Continental association

81. ARRANGEMENTS

[GR] [TR]

81.1 World Championships may be arranged with the consent of the ICF Board of Directors and are open to national teams of ICF member federations. No more than one team from each country may be entered in each category. [GR]

81.2 The venue shall have a minimum of 4 playing areas. For each playing area a warm-up area with 2 goals must be provided. [TR]

81.3 World Championships in Canoe Polo are held in five rounds. The first round takes place at the previous World Championships when the top identified number of places is filled. The second round will be held at the continents in the year prior to the World Championships to decide the remaining Continental places. Round 3, the preliminary round, Round 4, the intermediate round and Round 5, the final round are held in even-number years at a place and time in accordance with the ICF Canoe Polo Rules and the ICF Canoe Polo Committee's World Championship Manual. [TR]

81.4 World Championships shall be held for the following events:
Senior Women; Senior Men; Under-21 Women and Under-21 Men. [GR]

81.5 A valid World Championship is held only if at least six (6) National Federations in each category AND there must be at least three (3) Continents starting OVERALL in the competition. If during the competition a team/s drop out, the validity of the Championships is not affected. [GR]

81.6 The Appendix - Qualification World Canoe Polo Championships will detail the categories and number of places available in final 3 rounds of each category.

82. JURY AND OFFICIALS

[GR] [TR]

82.1 During the World Championships the supreme authority rests with the Jury which will consist of a maximum of 5 persons appointed by the ICF Board of Directors. One of the members of the Jury, a member of the ICF Board of Directors is named Chair of the Jury. Subordinate to this Jury are the Chief Official and other officials. [TR]

82.2 The Competition Committee shall consist of three officials who shall be in possession of a valid International Official Card, to the discipline related. They shall belong to different national federations. [GR]

82.3 The maximum number of officials to officiate the World Championships shall be eight (8) per game, excluding the Jury, Chief Official, Competition Organiser, Technical Organiser, Chief Referee, Chief Scrutineer and Chief Table Official. [TR]

82.4 Each team attending the World Championships will pay an administration fee (set by the ICF CAPC) to share the travel costs of 24 ICF qualified referee's and all other officials to officiate at the championships. These referee's will be selected by the ICF Canoe Polo Committee from the total list of ICF referee's based on their current ranking, continental and country representation, and recent refereeing history. The organising committee will be responsible for the full board accommodation and local transportation for all officials during the championships period. A maximum of 8 ICF qualified referee's may be invited by the ICF Canoe Polo committee to reduce the workload of referees. These additional referees will attend at their own cost. [TR]

82.5 Neutral Referees must referee all games, i.e. from countries other than those represented by the two teams playing. [TR]

83. APPOINTMENT

[TR]

83.1 The following groups are responsible for appointing the following officials:

Officials	World Championships
Jury	ICF Board of Directors
Chief Official	ICF Board of Directors
Competition Organiser	Host Federation
Technical Organiser	ICF CAP Committee
Chief Referee	ICF CAP Committee
Chief Scrutineer	ICF CAP Committee
Chief Table Official	ICF CAP Committee
Medical Official	Host Federation
Media Official	ICF CAP Committee / HF

83.2 The Medical Official will oversee the Anti-Doping Control and the welfare of the delegation members and competition personal.

83.3 The Media Official will oversee the media activities of the Championships.

84. ENTRIES

[GR]

84.1 The Appendix: ICF World Championships Canoe Polo Qualifying Rules will detail a schedule which determines when for the intermediate rounds an invitation has to be sent out, final date for accepting the invitation, the provisional program and program reaches the participating teams and when the delegation details have to be with the Organising Committee.

84.2 Charges may only be made in the contract between the ICF and the National Federation organising the Championships.

84.3 All matters relating to Invitations and accepting the invitation are managed by the ICF Canoe Polo Committee.

84.4 Except in the case of extenuating circumstances as determined in the sole discretion of the ICF Canoe Polo Committee, any team withdrawing from a World Championship after accepting the invitation of the ICF will not be eligible to enter the next World Championship.

85. SYSTEM, PROGRAMME AND SCHEDULE LIMITATIONS

[TR]

85.1 A World Championship shall not extend over more than five (5) successive days.

85.2 A team shall not be required to play games with their scheduled start spread over more than 9 hours on a single day.

85.3 A team shall not be required to play its first game of the day less than 12 hours after its last game of the preceding day.

85.4 A team shall not be required to play more than four (4) games on a day.

85.5 A team shall not be required to start more than two (2) games in any period of 4 hours.

85.6 A team shall not be required to start a game less than one (1) hour after completion of its previous game.

85.7 A team must play at least one game on the same day as playing in a Grand Final.

86. SELECTION OF COMPETITION SYSTEM

[TR]

86.1 The competition in each category shall be run in several rounds. The ICF Canoe Polo committee shall decide the number of rounds per category.

87. TRADEMARKS, ADVERTISING SYMBOLS AND WORDS

[TR]

87.1 Trademarks, advertising symbols and words must be identical and in the same position on the deck of the kayaks and clothing of all players.

87.2 Members of a team may have different trademarks, advertising symbols and words below the seam of a kayak.

87.3 Any kayak, accessory, or article of sportswear, which does not comply with the above mentioned conditions will be ineligible for use during a competition. Teams are responsible for ensuring their own equipment meets these rules and regulations.

88. THE BALL

[TR]

88.1 The ICF Canoe Polo Committee must approve the colour and brand of the balls to be used.

89. IDENTIFICATION

[TR]

89.1 The players of a team shall be numbered 1 to 10.

90. PLAYING TIME

[TR]

90.1 Playing time shall be two (2) periods each of ten (10) minutes, unless overtime is needed to determine a result. There will be no shorter minimum playing time.

90.2 The half time interval shall be three (3) minutes. There will be no shorter minimum half time interval.

90.3 A scoreboard shall be maintained to clearly display the time remaining in any period and score to the players, officials. The scoreboard will automatically indicate the end of the period of playing time by the use of a loud signal.

90.4 Shot Clock - will be used throughout World Championships - see ICF website (www.canoeicf.com) for Appendix Shot Clock for detail.

91. PROTEST

[GR]

91.1. A protest made during the competition must be addressed to the Competition Committee and handed to the Chief Official not later than 20 minutes after the end of the relevant game.

91.2. The Chief Official must notify immediately all parties involved in the protest. After 20 minutes the Competition Committee will start the deliberation on the protest. The decision of the Competition Committee on the protest must be confirmed in writing, not later than 10 minutes after closing of the protest, giving reasons for the decision. The Chief Official must hand the decision to the team leaders. The team leaders must acknowledge receipt of it by signing the Competition Committee's copy and recording the time for the case of any further appeal.

91.3. All protests shall be made in writing and be accompanied by a fee of 25 Euros (or equal amount in the currency of the country in which the championships are arranged). The fee will be refunded if the protest is upheld.

91.4. When a protest or a report is made against a player or a team, the team leader of the player or team in question shall be presented with a copy of the protest or report to read.

92. APPEAL

[GR]

92.1 An appeal against a decision of the Competition Committee must be addressed to the Chairman of the Jury in writing and be accompanied by a fee of 25 Euros (or equal amount in the currency of the country in which the championships are arranged). The appeal must be handed to the Chairman of the Jury not later than 20 minutes after the team leader has been informed with a written communication of the decision against the player or team and has signed the receipt given. The fee will be refunded if the appeal is upheld.

92.2 At the World Championships the decision of the Jury is final.

93. AWARDS

[GR]

93.1 The championships medals shall be given according to the Olympic Protocol.

93.2 The championships medals shall be given in three values: gilded for 1st place, silvered for 2nd place and bronze for 3rd place and shall be furnished by the ICF at the expense of the organising national federation.

93.3 Each medal shall be inscribed with the name, year and category of the competition for which they are awarded.

93.4 The medals must on no account be presented to any other persons than those who have won championships event.

93.5 A perpetual trophy will be presented to the winning team in each category.

93.6 Only these medals, and the perpetual trophy to the exclusion of all other prizes, are to be presented at the official ceremony. Other prizes may be presented on an occasion other than this ceremony.

93.7 To maintain the dignity and solemnity of the presentation ceremony the players receiving medals must wear training suits or national uniform.

94. ANTI-DOPING

[GR]

94.1 Anti-Doping control shall be conducted in accordance with the ICF Anti-Doping control regulations under the supervision of the ICF Medical & Anti-Doping Committee.

95. RESULTS AND REPORTS

[GR]

95.1 The results, reports of any protest made, and other necessary documents concerning the games, must be sent to the ICF Headquarters by the organising national federation on the day of the final.

95.2 The results concerning the games must be sent to the ICF Bulletin Editor by the organising federation on the day of the final.

CHAPTER V - SPECIAL RULES FOR WORLD GAMES

Rules in this section, specifically for World Games are in addition to, or to override, those in earlier sections.

96. ENTRIES TO WORLD GAMES

96.1 Eligible National Federations will be invited based on their final position at the World Championships in the year prior to the World Games.

96.2 The International World Games Association in consultation with the ICF will agree a number of athlete places available - to date two categories, Men & Women, and 6 teams in each category.

96.3 The host country for the World Games will be entitled, in each category, to 1 team place.

96.4 Confirmation of available categories and team numbers for each World Games will be via World Championship Bulletin/s and ICF HQ.

97. TRADEMARKS, ADVERTISING SYMBOLS AND WORDS

[TR]

97.1 Trademarks, advertising symbols and words must be identical and in the same position on the kayaks and clothing of all players.

97.2 Any kayak, accessory, or article of sportswear, which does not comply with the above mentioned conditions will be ineligible for use during a competition. Teams are responsible for ensuring their own equipment meets these rules and regulations.

98. SYSTEM; PROGRAMME AND SCHEDULE LIMITATIONS

[TR]

98.1 World Games shall not extend over more than five (5) successive days.

98.2 A team shall not be required to play its first game of the day less than 12 hours after its last game of the

preceding day.

98.3 A team shall not be required to start more than two (2) games in any period of 4 hours.

98.4 A team shall not be required to start a game less than one (1) hour after completion of its previous game.

98.5 A team must play at least one game on the same day as playing in a Grand Final.

99. REFEREES

1. The ICF Canoe Polo Committee will invite an appropriate number of ICF referee's (traditionally 12) based on their current ranking, continental and country representation, recent refereeing history and location of the World Games. Dependant on any available ICF budget it may be necessary to impose a fee on participating teams to cover the costs of any referees invited. Clarification of any fee will be via World Games Bulletin/s and ICF HQ.

APPENDIX I - REFEREE HAND SIGNALS

100. REFEREE HAND SIGNALS

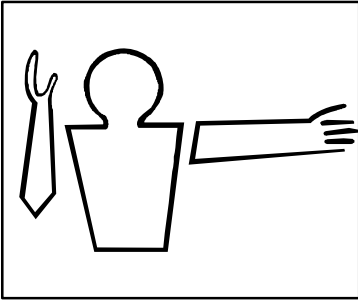

1. START / INFRINGEMENT

Arm forward and bent upwards with palm open and facing sideways head level.

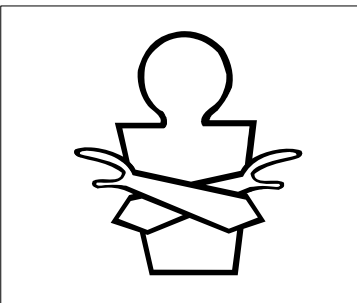

2. COMPLETION OF HALF / FULL TIME

Arms crossed in front of chest. Palms out.



3. GOAL

Arms extended, palms together. Point to centre of field.

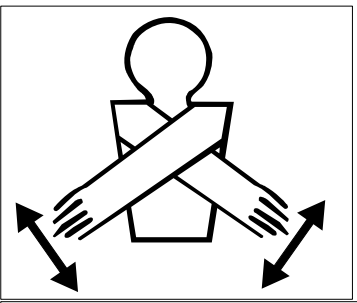

4. DISALLOWED GOAL

Repeated crossing of arms at thigh level. Palms open.

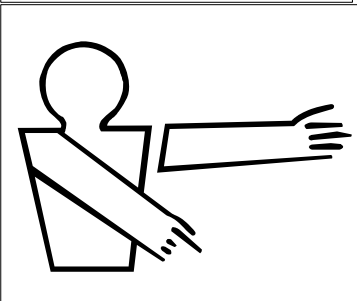

5. SIDELINE THROW / CORNER

Point at sideline. Other arm showing direction of play.

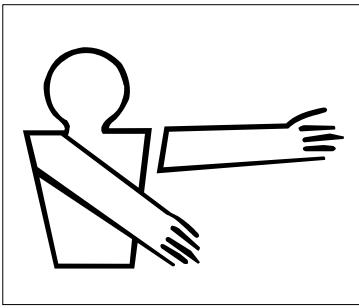

6. GOAL LINE THROW

Point open hand, arm extended along goal line. Other arm showing direction of play.

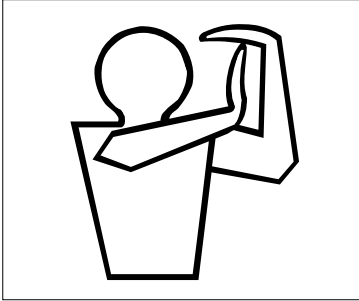

7. TIME OUT

Form "T" with hands above head.

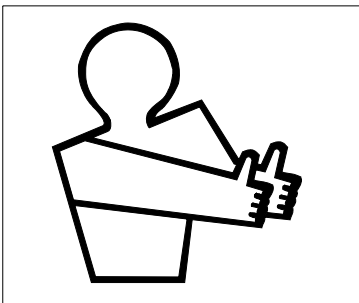

8. REFEREE'S BALL

Arms extended forward at shoulder level, fists clenched, thumbs up.

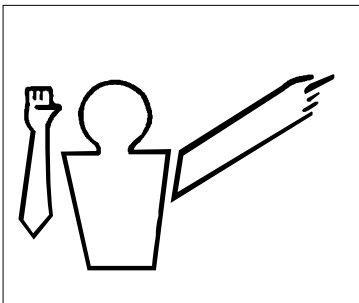

9. OBSTRUCTION / HOLDING

Hold one arm up in the air fist clenched for the period of 2 seconds, and then point at the position where the free shot has to be taken. Other arm showing direction of play.

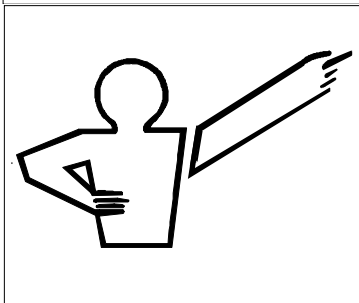

10. ILLEGAL TACKLE

Hold clenched fist against hip for the period of 2 seconds, and then point at the position where the free shot has to be taken. Other arm showing direction of play.

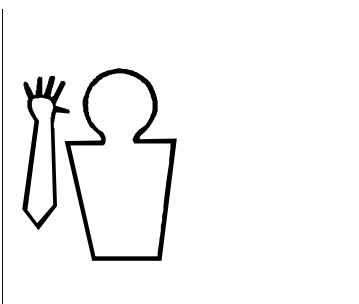

11. 5 SECONDS / POSSESSION

Hold hand up at side at head level, palm forward. Spread all fingers for the period of 2 seconds, and then point at the position where the free shot has to be taken. Other arm showing direction of play.

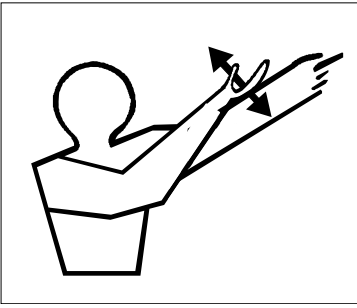

12. ILLEGAL USE OF PADDLE

The side of the other hand repeatedly chops the upper arm showing in direction of play for the period of 2 seconds, and then point at the position where the free shot has to be taken.

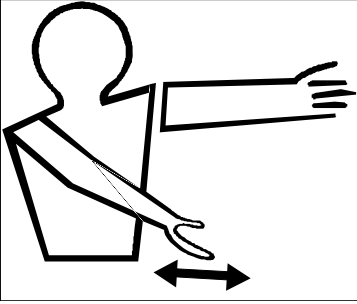

13. PLAY ON / ADVANTAGE

One arm elbow bent, hand pushing back and forth across the body at hip level at least three (3) times. Other arm showing direction of play.

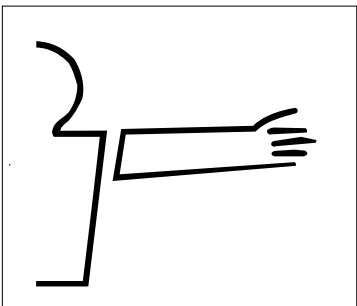

14. FREE THROW

Arm extended, palm open, pointing in direction of play parallel to side of field. Other arm showing offence signal (1, 5, 6, 11 or 13).

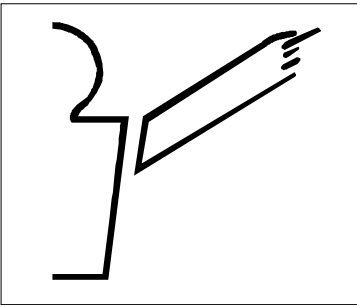

15. FREE SHOT

Arm extended, index finger pointing at goal in direction of attack. Other arm showing offence signal (9, 10, 11 or 12).

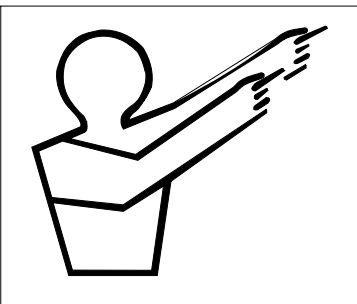

16. GOAL PENALTY SHOT

Both arms extended index fingers together and pointing at goal.

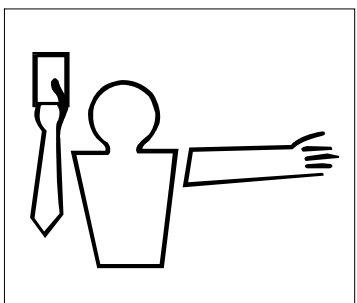

17. SHOWING CARDS

Green card - warning
Yellow card - 2 minutes send off
Red card - send off for the rest of game

Hold card above head. Other arm pointing to player. If necessary, indicate number of player with fingers. Use clenched fist to indicate ten where a number 10 or larger is required.

18. UNSPORTING BEHAVIOUR

One index finger on one hand waved from side to side repeatedly

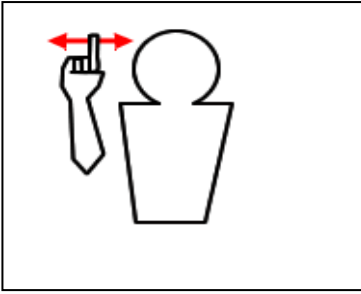

APPENDIX II - SCRUTINEERING

101. KAYAK – GENERAL

1. A canoe polo kayak with integrated bumpers, or a kayak to have padding fixed later, must not be longer than 3000 mm and must not be wider than 600 mm.
2. Front and rear 'impact zones' must be rounded and padded as these rules so as to not cause injury to other players and to reduce/prevent damage to their equipment. For kayaks with integrated padding the length of the kayak will be measured with the padding in place.
3. The weight, including padding, may not be less than 7kg.
4. There may be no sharp projections or edges. All curves must stay within these rules.
5. Padding as in these rules, must be firmly fixed to the front and rear of the kayak.
6. The kayak will be scrutinized with gauges.
7. All references to plan, side, section, zones ends and axis refer to the kayak as set up in a normal position, and remaining in the same position for all measurements.
8. Kayak-Safety requirements
 - 8.1. The kayak may have no sharp projections or edges or other dangerous features. For glass (composite) kayaks, all metal bolts, screws or other fixing devices should have low profile parts on the surface, be smooth to the touch and be recessed wherever possible. Concave sections are allowable throughout the kayak so long as they do not present themselves as a dangerous feature. All metal bolts, screws or other fixing devices present in plastic kayaks must be recessed. Carry handles of any type are not permitted.
 - 8.2. The kayak must have soft, shock absorbing material firmly affixed to the front and rear impact ends, sufficient to prevent injury to players and to reduce damage to equipment. The padding must comply with the detailed specifications.

8.3. The kayak must have sufficient buoyancy to keep it afloat, so that some part breaks the surface of the water, even when it is completely full of water.

9. KAYAK PLAN VIEW OF SECTIONS/ZONES

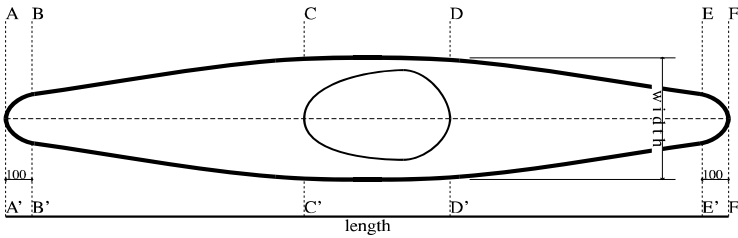

Length: Maximum 3000 mm

Width: Maximum 600 mm

Section AA' to BB' - Front Impact Zone 100 mm
minimum radius at any point on B-A-B'

Section BB' to CC' - Front Section

Section CC' to DD' - Cockpit Section

Section DD' to EE' - Rear Section

Section EE' to FF' - Rear Impact Zone 100 mm
minimum radius at any point on E-F-E'

10. Kayak - Edge

10.1. The edge, is the line around the kayak (not necessarily the join or gunwale line) where the side or end meets the vertical tangent. References to the top, upper, lower or bottom of a kayak are relative to this edge.

10.2. The edge of the kayak must be of sufficient radius so as not to cause injury to a player on impact.

10.3. In profile, the minimum radius of curvature for the edge in each section is detailed in the following paragraphs.

10.4. In plan, the minimum radius of convex curvature for the edge is 100 mm throughout the edge of the kayak.

11. Kayak - Shape in Plan

11.1. In both front and rear impact zones, the minimum radius of convex curvature allowed is 100 mm. A minimum width of 200 mm within the first 100 mm must be reached. This first 100 mm is measured from the back of the padding against the kayak.

12. Kayak-Top and Bottom surface

12.1. The top and bottom surfaces including impact zones (excluding those parts of the cockpit covered by a

spray deck) must be smooth so as not to cause injury to a player.

12.2. Top Surface in profile: Minimum radius of convex curvature allowed in the top surface of the impact zone is 20 mm.

12.3. Section AA' to FF' - the entire length of the kayak top, edge and bottom surface in profile. For the part 20mm measured vertically above the edge (point Y), and for the bottom surface the minimum radius of convex curvature allowed is 30mm.

12.4. Section BB'-FF' - For the top surface in profile the minimum radius of convex curvature allowed throughout the entire length of the kayak except the front impact zone is 5mm.

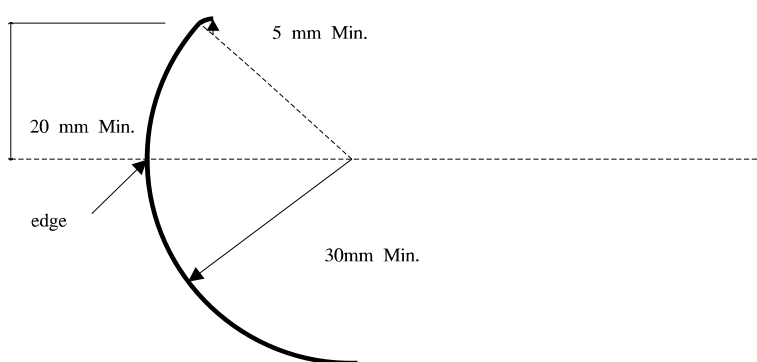

12.5. Recesses in the hull or deck for the purpose of hiding bolt or screw heads etc. are to be permitted. Recesses should be safer than a projecting fixing device in order to be legal. Where recesses are provided to improve safety by eliminating projecting fixing devices, the 5mm radius shall be relaxed as far as it would cover the radius of any transition curve between the deck and the side surfaces of any such recess.

13. Kayak - Depth

13.1. The depth at the cockpit must be sufficient to provide some protection from impact for the player.

13.2. Throughout the length of the cockpit section of the kayak (from CC' to DD'), on each side of the cockpit, the kayak must be at least 160 mm deep, as seen in profile, not including the cockpit edge.

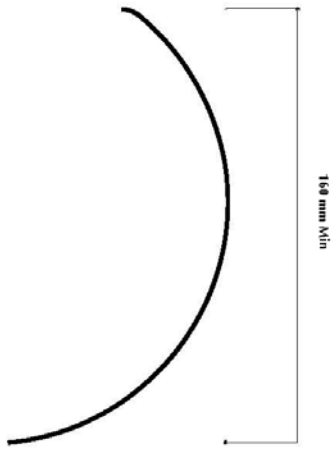

102. KAYAK GAUGES

1. Standardised gauges are to be used to test compliance with the specifications. The gauges need to be made from sheet aluminium and precisely engineered.

2. To gauge rise from the edge of the kayak, hold edge W-X of the gauge vertical and perpendicular to the kayak. Align 'edge mark' with the edge of the kayak. Side Y-Y' towards the kayak. Point Y indicates specified rise from the edge.

- If the 'edge mark' touches the edge, but point Y does not touch the kayak, then either the radius at that point is too small or does not rise high enough.
- If any points between Y and 'edge mark' on the kayak touch the gauge, but not both Y and 'edge mark', then the radius at that point is too small. If the kayak is exactly to minimum specification point Y and 'edge mark' and all points between will be touching.
- If both points Y and 'edge mark' touch, but no points between, then the radius at the 'edge mark' must be too small.
- If that portion of the kayak being tested in general is of more than sufficient radius, point Y will touch, but no other part. In this case the rise test is passed.

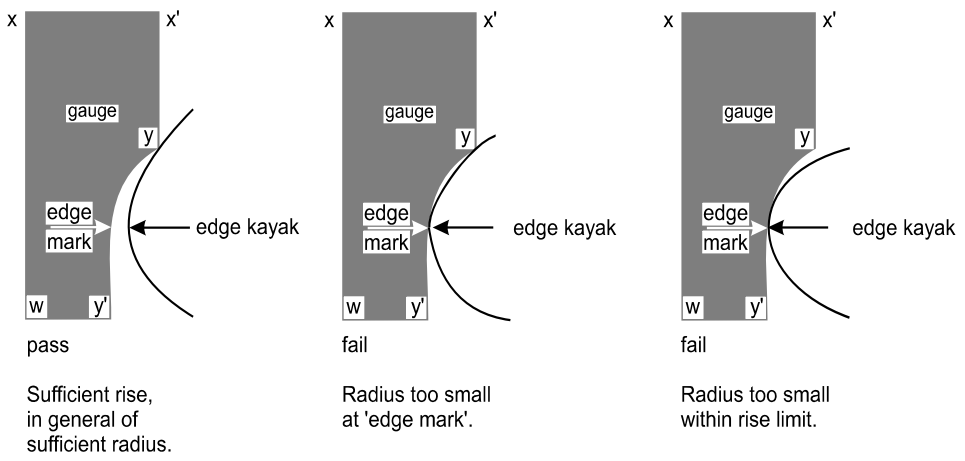

3. To gauge the radius of curvature the radius portion of the appropriate gauge, must be applied perpendicular to the surface being tested. If both points X and X' touch the surface at the same time without the rest of the kayak, the test is passed.

4. The gauges to use for the measuring of the different sections are:

4.1. Gauge 1, edge gauge, 30 mm radius, 20 mm rise must be used to measure section AA' to FF' - entire length of kayak.

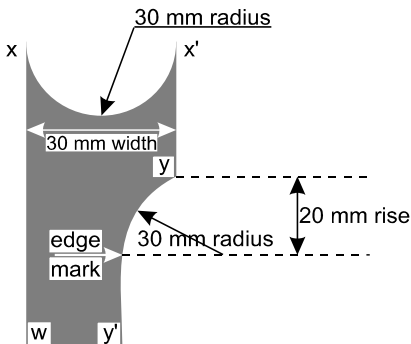

4.2. Gauge 2, Impact zone gauge, 100 mm radius, must be used to measure in plan sections AA' to BB' (front) and EE' to FF' (back).

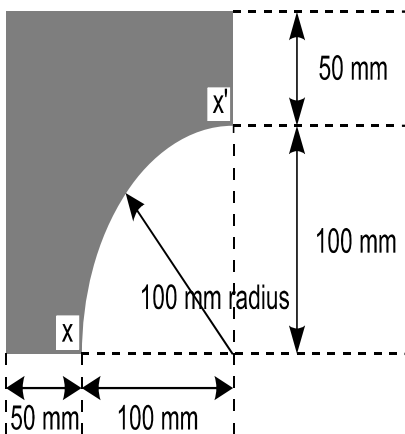

4.3. Gauge 3, depth gauge, 160 mm rise, must be used to measure section CC' to DD' (cockpit area).

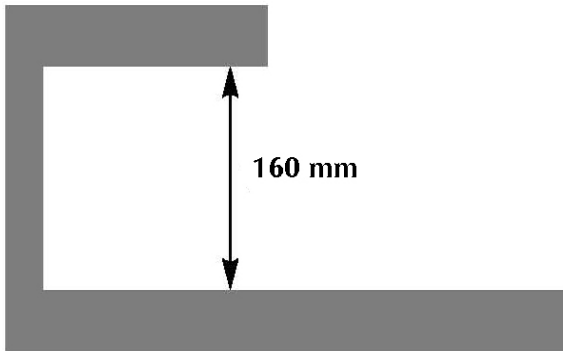

103. PADDING

1. Canoe Polo kayaks with both front and rear integrated bumpers fitted cannot be longer than 3000mm. Kayaks without integrated bumpers may be a maximum of 3100mm once any padding is attached. Kayaks with one integrated bumper and one non-integrated bumper cannot be longer than 3000mm prior to the non-integrated bumper being attached.

1.1. Soft shock absorbing padding a minimum of 30 mm thick (when uncompressed) at the horizontal centreline and 50 mm wide must be firmly attached to cover the edges of the front and back of the kayak at the ends and extend at least 100 mm from the ends.

1.2. Soft shock absorbing material must be homogeneous (e.g.: foam, soft rubber). If it relies on a composite construction for its minimum thickness and shock absorbing property, then the essential shock absorbing property of the padding must not be lost under compression. The characteristics should be measured at the temperatures that will prevail during the competition.

1.3. The 30 mm thick must be reached on the horizontal centreline. It may be reduced to not less than 20 mm thick at a width of 50mm. The padding must be compressible (by a scrutineer's or player's thumb) by at least 10 mm. The padding must not be compressible to less than 10 mm thickness. The thickness and compression are measured parallel to the axis of the kayak.

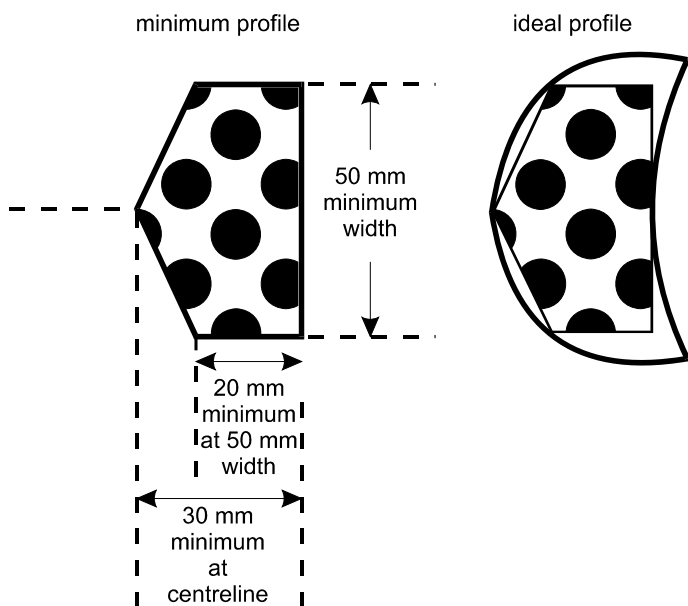

1.4. The padding must be positioned on the edge (see definition of edge in kayak specifications) to cover at least 15 mm above and below the edge.

1.5. The padding must be attached in a way that the edges and ends are not, liable to catch on players or equipment. If tubing is used, the ends of the tubing must be closed or covered.

1.6. If rivets or bolts (or similar) are used to attach the padding, they must be recessed at least 20mm into the padding from the outer most part.

1.7. Any method of fitting should ensure there is no possibility of the bumper either falling off or out of position during the course of a competition.

1.8. For integrated bumpers there should be no (minimal) gap between the start/edge of the bumper and the part of the kayak to which it meets and any part of the kayak that meets the bumper should have a minimum of 5 mm radii.

1.9. The shape of the kayak beneath the integrated bumper is not important so long as while the bumper is in place the whole kayak meets the specifications outlined in this appendix.

1.10. For integrated bumpers in general their profile should so far as possible follow the profile of the kayak ends. The integrated bumper must be appropriate for that design of kayak.

104. PADDLE

1. The paddle must be double-bladed with no sharp projections, edges, holes or other dangerous features. The blades shape, thickness and radii must stay within these rules. The paddle will be scrutineered with a gauge.
2. The blades are to be no more than 600 mm x 250 mm in plan measured from where the shaft meets the blade. The edges must have a minimum radius of 30 mm in plan and a minimum thickness of 5 mm. Metal tipped blades are not allowed.
3. The exception to this is those blades where the metal edge is an integral part of the construction as opposed to a rim or trim added to the outside by any means. However if at any point the internal metal component is exposed then it will be considered un-fit for use in canoe polo.

105. PADDLE GAUGE

1. A standardised gauge is to be used to test compliance with the specifications. The gauge needs to be from sheet aluminium and precisely engineered.
2. To gauge the radius of curvature the radius portion of the paddle gauge, must be applied perpendicular to the surface being tested. If both points X and X' touch the surface at the same time without the rest of the paddle, the radius test is passed.
To gauge the thickness of the paddle-blade, hold the slot over the blade. If the paddle does not enter the slot, the test is passed.

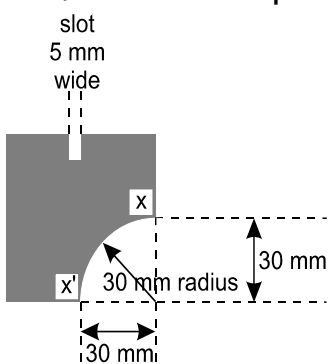

106. HELMET

1. The helmet must be a safety one and suitable. They must protect against any blow, which may be reasonably anticipated in the course of a game covering from the jaw line to the rear point of the skull, such that no contact is possible between the skull and a blade on a horizontally held paddle.

107. FACE-PROTECTOR

1. The face protector must be of a strong material such as steel or any equal strong material. An object in the shape of a cube no smaller than 7x7x7 cm must not be able to enter through the grill of the face protector. The face protector must be securely fixed to the helmet, without sharp or dangerous fixings. They may not present any sharp or dangerous part. It must protect against any blow that may be reasonably anticipated in the course of a game. It must cover the entire face of the player beginning at the lower level of the chin and covering the surface between the two temples.

108. BODY PROTECTION

1. The body protection in the form of a Personal Floatation Device(PDF) that meets suitable accreditation standards for Canoeing. The padding must be at least 15 mm thick. The padding must protect against any impact from other players equipment, which may be reasonably anticipated in the course of a game. The padding must begin no more than 100 mm above the cockpit rim measured at the player's side, with the player sitting normally in their kayak. The gap between the top of the protection at the side and the top of the armpit measured with the arm horizontal must be less than 100 mm.

APPENDIX III: PLAYING AREA

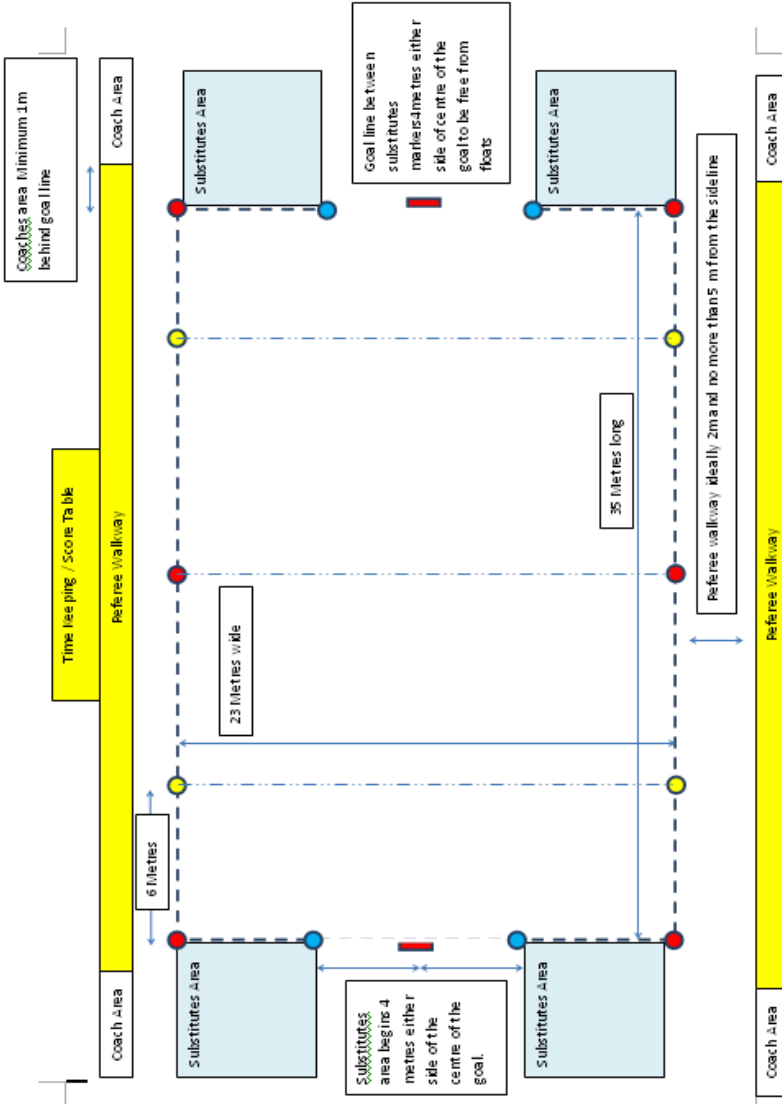

Diagram can be found on the ICF website (www.canoeicf.com)

APPENDIX IV: GAMES AND LEAGUE SYSTEMS

Examples can be found on the ICF website (www.canoeicf.com).

APPENDIX V: SHOT CLOCK

The following Shot Clock rules will be used in any World Games, World Championships and are recommended for use in Continental Championships.

(The shot clock rules may also be used for any other competition provided all teams are clearly notified it will be used).

1. A team must attempt a shot at goal within 60 seconds of gaining possession or control of the ball. Failure to do so will result in possession of the ball and a free shot being awarded to the other team. The free shot is to be taken where the ball is at the time of the shot clock expiring. If the ball is out of play at the time the shot clock expires - the free shot will be taken from the closest point to where the ball went out of play. Signals 11 and 15 applies

2. The shot clock will be operated by the time keeper. The shot clock will be directly linked to the main game clock and will stop whenever the main game clock stops either after a goal or when either referee calls time out, or when the ball is out of play. The shot clock will restart when the referee restarts play with a whistle or when the player taking the throw holds the ball up to take the throw.

3. The shot clock will be clearly visible to all players and spectators on the field either directly above, or to the side of each goal, or in the corner of the field, on the same side as the controlling referee.

4. The shot clock will have an audible signal device of a distinctive tone that can be clearly heard by all players and officials involved in a game. The tone of the shot clock signal must be different to the main time-keepers signal. The shot clock signal will sound at the completion of 60 seconds indicating that the shot clock time has expired. The referees will confirm the change of possession with a single blast of the whistle and award a free shot to the opposition.

5. For a goal to be scored, the shot at goal must have been taken prior to the start of the shot clock expiry signal. If the ball is in flight at the time of the signal it

will be allowed to travel to completion. The ball must have left the players hand prior to the signal sounding.

6. The shot clock will be reset whenever there is a shot at goal or a change in team possession. If a team attempts a shot at goal and the ball rebounds out of bounds or back into play, the shot clock will be reset even if the same team that took the shot at goal regains possession of the ball. (Rewards attacking team for attempting shot in time).

7. If a team that is not attempting a shot at goal loses control of the ball out of bounds and regain possession as a result of a sideline throw or corner throw, the shot clock will not be reset.

8. If two players of opposing teams momentarily share possession or control of the ball, the shot clock will only be reset if there is a clear change of possession of the ball to the other team. (Covers loose ball situations where 2 players compete for it).

9. If a team momentarily loses control or possession of the ball and that team regains control or possession the shot clock will not be reset. (Covers loose passes or deflections where control is lost momentarily - rewards defense for pressure).

10. The shot clock will be reset if a team receives a free shot or if the referees plays advantage as a result of a foul by the opposing team.

(Covers blocked passes that go out of bounds and therefore rewards defending team for pressure and prevents teams repeatedly fouling to cause shot clock time to run out should also result in cards).